

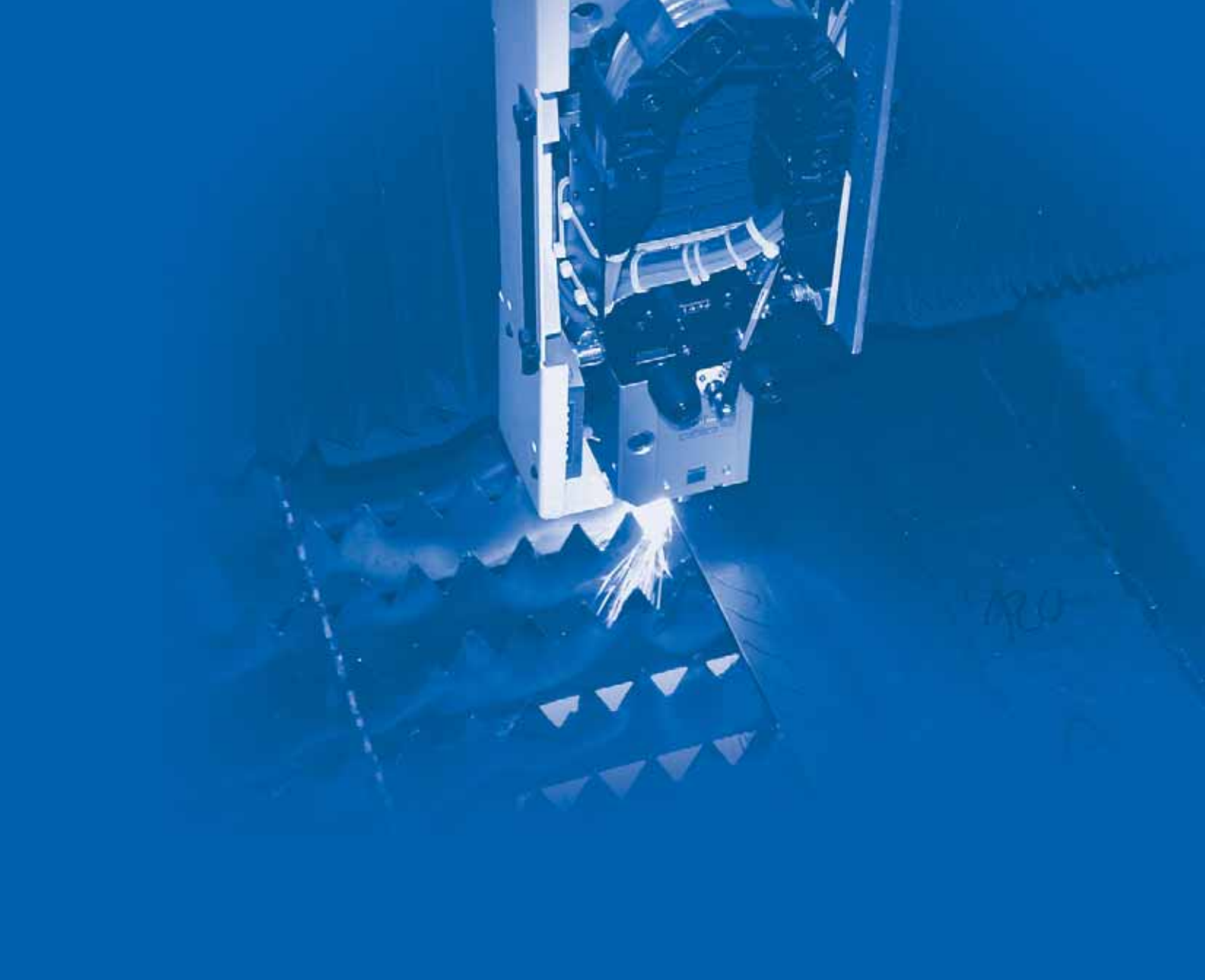

Ipari kések







Profilové a hoblovací nože

Č. 700
Zn. „TATRA“
savětrně nástrojová ocel.

Č. 701
Zn. „HAD“
SPECIAL QUALITY
savětrně chrom. sůlfron.
válcované oceli.

PROFÍLOVÉ NOŽE
dle naší profilové listiny, dřevěná vrstva neb
savětrně síkřev. s slovětrným výřez.
8 mm silib.

**Silnější nože určujeme za každé mm výšší
síly o 10% více.**
Nože s uzavřenými výřezy jsou o 10% šetrší.

Šířka listu mm	40	50	60	70	80	90	100	110	120	130	140	150	160
Délka nože, Č. 700 k. 24	26	34	40	46	52	60	66	70	76	82	88	94	100
„do 90 mm, Č. 701 k. 36	42	51	60	69	78	89	99	109	117	127	137	147	157
93—100 mm, Č. 700 k. 26	30	36	42	50	56	64	70	76	84	90	97	105	113
„do 90 mm, Č. 701 k. 39	45	54	63	72	81	91	101	111	120	130	140	150	160
101—120 mm, Č. 700 k. 28	32	39	46	54	62	70	78	86	94	102	110	118	126
„do 90 mm, Č. 701 k. 42	48	57	66	75	84	93	102	111	120	130	140	150	160
121—130 mm, Č. 700 k. 30	34	40	46	52	58	64	70	76	82	88	94	100	110
„do 90 mm, Č. 701 k. 45	51	60	69	78	87	96	105	114	123	132	141	150	160

Ceny rozloženy na 1 lín.

Hoblovací nože na dřeviny a podobně.

Tvar B
Zn. „TATRA“
savětrně nástrojová ocel,
Č. 702

Tvar C
Zn. „HAD SPECIAL QUALITY“
savětrně chrom. sůlfron.
válcované oceli,
Č. 703

Tvar D

Šířka nože mm	50	70	100	120	140	160
Síla 6 mm, Č. 702, 1 lín. k.	308	419	602	819	1040	1290
„do 70 mm, Č. 703, 1 lín. k.	352	475	672	911	1160	1440
Síla 7 mm, Č. 702, 1 lín. k.	396	533	756	1029	1320	1680
„do 70 mm, Č. 703, 1 lín. k.	450	606	852	1143	1470	1860
Síla 8 mm, Č. 702, 1 lín. k.	399	540	768	1056	1380	1764
„do 70 mm, Č. 703, 1 lín. k.	456	612	864	1176	1512	1944
Síla 10 mm, Č. 702, 1 lín. k.	502	672	954	1296	1680	2160
„do 70 mm, Č. 703, 1 lín. k.	570	756	1080	1458	1890	2430
Síla 12 mm, Č. 702, 1 lín. k.	545	732	1038	1392	1800	2304
„do 70 mm, Č. 703, 1 lín. k.	624	834	1164	1554	2016	2616

lín = 1 listový metř.

Č. 704
Hoblovací nože
s klopou,
lín o 80%, šetrší než
obč. nože č. 747, 748
a 749.

Č. 705
Nože pro výrobu dřevitě vlny
o 220 mm dlouhé, 10 mm široké.

Síla mm	1,5	2	2,5	3
1 kus k.	1,50	1,90	2,30	2,70

Při objemové záležitosti vzorek, šablóna neb přenosý náčrt.

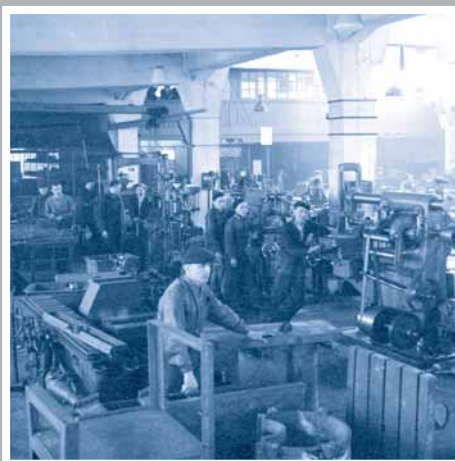
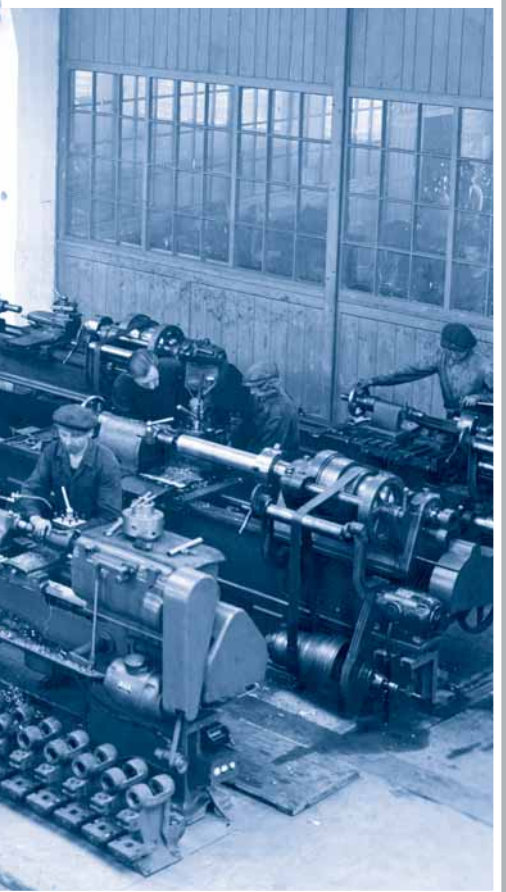
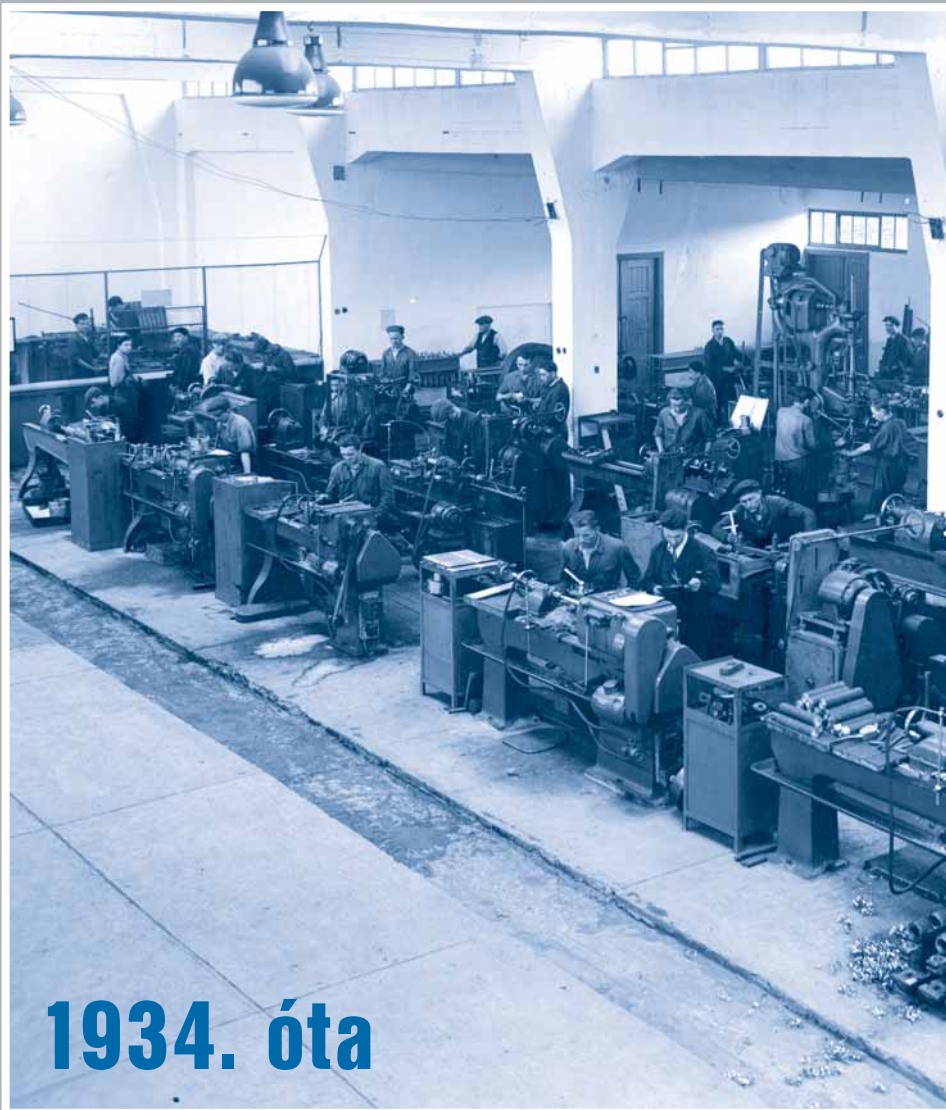



IPARI KÉSEK GYÁRTÁSA

A PILANA TOOLS KNIVES jelenleg az egyik legnagyobb ipari kés gyártó Európában. 175 magasan kvalifikált munkaerőnek köszönhetően cégünk éves árbevétele eléri a 10 mill. eurót (280 000 db örlőkés, 250 000 db gyalugépkés, 40 000 db maróblenketta és 180 000 ipari kés). A kiváló minőségnek és a kedvező árnak köszönhetően a kések 95%-t a világ több, mint 70 országába exportáljuk. A gyártáshoz speciálisan a kések számára kifejlesztett alapanyagot használunk (DIN 1.3355, 1.3343, 1.2379, 1.2631, 1.2362), melyet neves német, osztrák és svéd acélgyártóktól szerzünk be. Késeink a legextrémebb munkakörülmények között is használhatók. A termeléshez a legmodernebb gyártási technológiát használjuk – lézeres kivágás, számítógéppel vezérelt edzőkemencékben történő hőkezelés és CNC vezérelt gépi forgácsolás. A gyártási technológia minőségét folyamatosan javítjuk, a tavalyi év folyamán több, mint 1 mill. euró értékű fejlesztést hajtottunk végre. 10.000 m²-en 100-nál több gépünk működik. A termelésirányítás számítógépes vezérléssel történik. Vállalatunk pénzügyi helyzete stabil.

MINŐSÉG ELLENŐRZÉS

A minőség biztosításának az alapja a folyamatos ellenőrzés, az állandó technológiai fejlesztés és a több, mint hetvenéves szakmai tapasztalat. ISO 9001 minőségbiztosítási rendszer szerint működünk. A vállalat minden egyes alkalmazottja személyesen felel munkája minőségéért, a legmagasabb szint elérésére törekszünk minden gyártási fázisban, hogy biztosan elejét vegyünk az esetlegesen felmerülő vásárlói panaszoknak. Célunk az elégedett vásárló.

MIÉRT VANNAK VEVŐINK A VILÁG TÖBB, MINT 70 ORSZÁGÁBÓL:

- » A PILANA régi és elismert márka
- » Termékeink ár – érték aránya kiváló
- » Profi minőséget szállítunk, vásárlóink tudják mit vesznek
- » Egyedi megrendelés alapján is gyártunk szerszámokat
- » Folyamatosan javítjuk termékeink minőségét és növeljük használati értéküket, közvetlen szállításokkal csökkentjük a költségeket



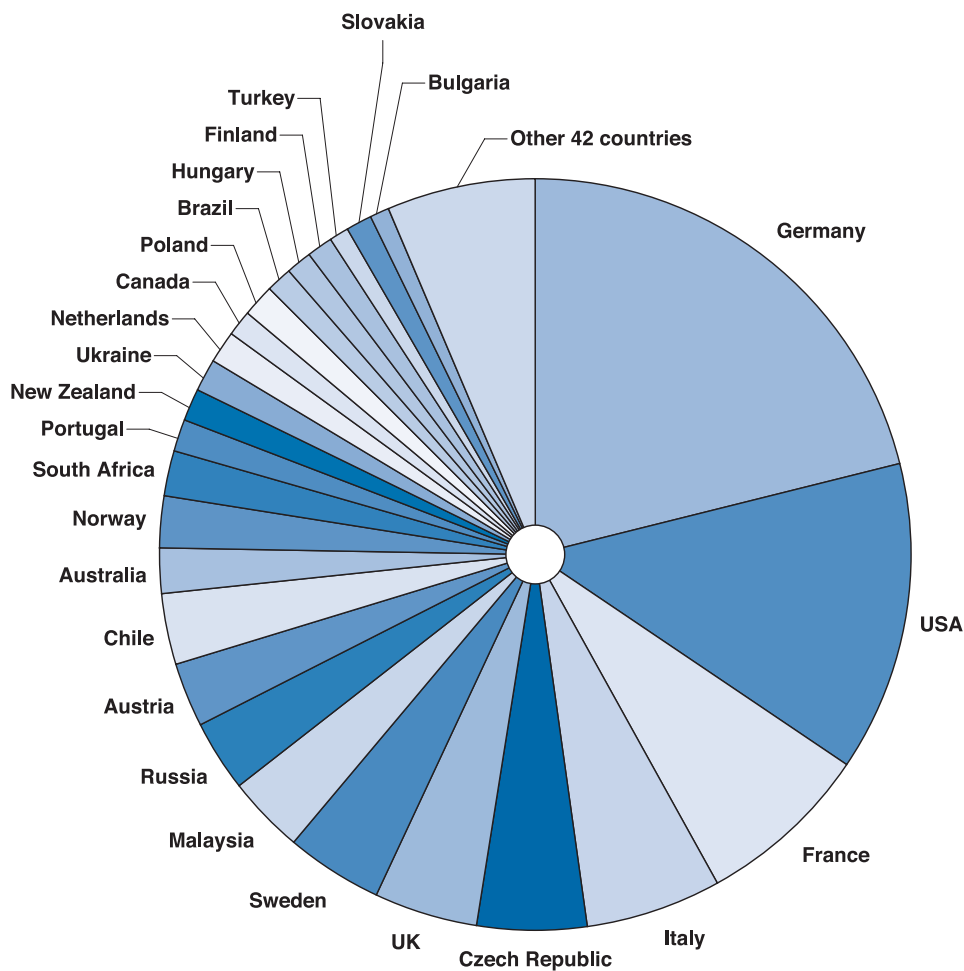



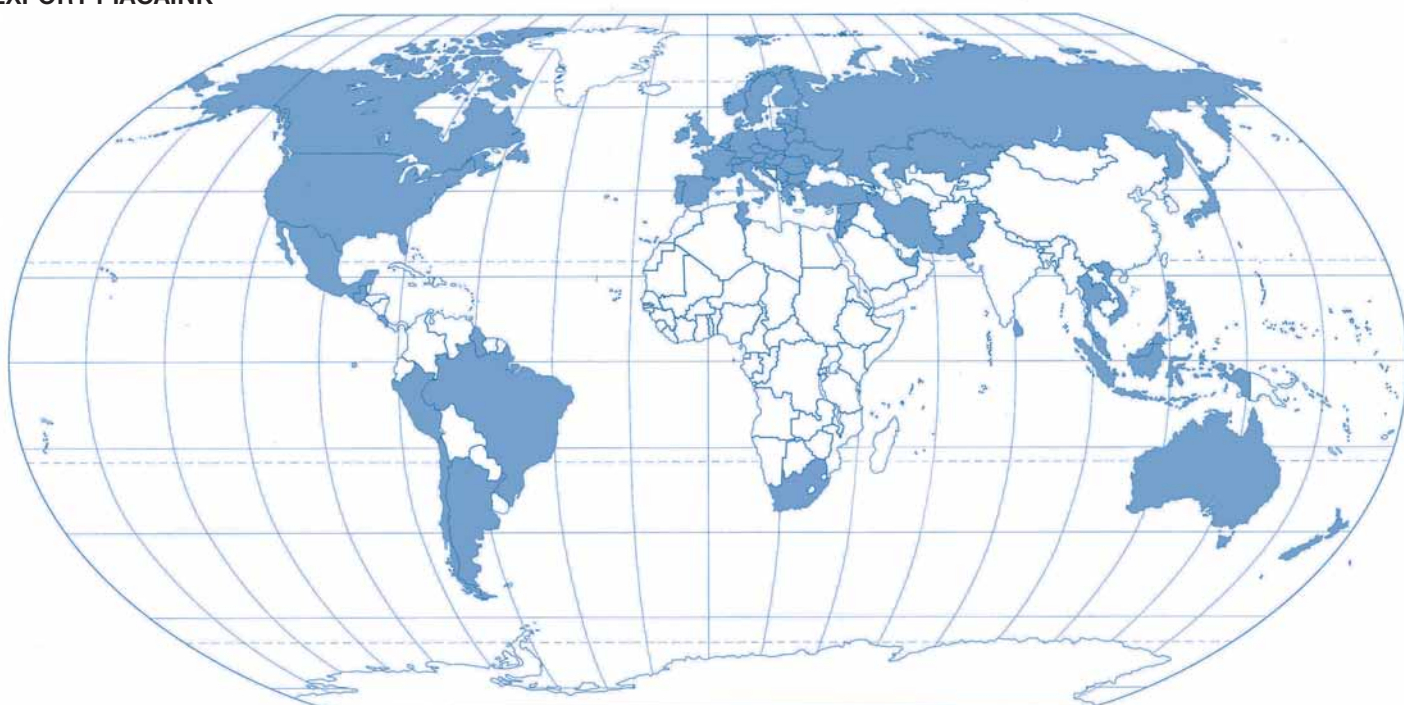

PILANA TOOLS KNIVES EXPORT



EXPORT PIACAINK



Tartalom

	Gyalugépkések, rovátkolt maróblanketták	5 - 8
	Aprítógépkések faforgácslapokhoz	9 - 13
	Gyűrűs aprítógépkés tartozékok	14
	Daráló kések	15 - 34
	Gerenda megmunkáló kések	35 - 40
	Funér hámozó - hántoló kések	41 - 48
	Korona kések	49 - 54
	Aprítógépkések műanyagra	55 - 66
	Ipari kések egyéb felhasználásra	67 - 68

Késgyártáshoz felhasznált acél anyagösszetétele szabványok szerint

EURÓPA	VEGYI ÖSSZETÉTEL	USA	CSEH KÖZTÁRSASÁG	AUSZTRIA	NÉMETORSZÁG	FRANCIAORSZÁG	LENGY- ELO- RSZÁG	AUSZTRIA	NAGY- BRITAN- NIA	SPANY- OL- ORSZÁG	SZLOVÉNIA
W.-Nr.		AISI,SAE	ČSN	BÖHLER	DIN 13750	AFNOR	PN/H	GOST	BS	UNE	Steel Ravne
1.2003	C 0,75; Si 0,35; Mn 0,7; Cr 0,35	O 1	13180		75Cr1			8Ch			75Cr1
1.2235	C 0,8; Si 0,32; Mn 0,4; Cr 0,55; V 0,2		19419		80CrV2		NCV 1	8ChF		F520J	80CrU2
1.0605	C 0,75; Si 0,25; Mn 0,7	1074			C75			75	80 HS		Č 1832
1.2067	C 1,02; Si 0,25; Mn 0,35; Cr 1,5	L 3			100Cr6		NC4	9Ch1	BL 3		O CR 4EX
1.2379	C 1,55; Si 0,25; Mn 0,35; Cr 11,8; Mo 0,8; V 0,95	D 2	19573	K110	X155CrVMo12-1	Z160CDV12	NC11LV	Ch12MF	BD 2	F520A	OCR12VM
1.2080	C 2; Si 0,25; Mn 0,3; Cr 11,5		19436	K100	X210Cr12	Z200C12	NC11	CH12	BD 3	F5212	OCR 12
1.2436	C 2,1; Si 0,25; Mn 0,3; Cr 11,5; W 0,7	D 6	19436	K107	X210CrW12	Z210CrW12-01	NC11	CH12	BD 6	F5212	OCR12SP
1.2362	C 0,62; Si 1,1; Mn 0,4; Cr 5,3; Mo 1,2; V 0,3	A 8	19569	K313	X63CpMoV5-1			6Ch4M2FS			OCR12V2
1.2363	C 1; Si 0,3; Mn 0,55; Cr 5,2; Mo 1,1; V 0,2	A 2		K305	X100CrMoV5-1	X100CrMoV5-1	NVLV	Ch6VF	BA 2	F536	CRH 78L
1.2631	C 0,53; Si 0,5; Mn 0,3; Cr 7,5; Mo 1,6; W 1,5		19559	K350	X50CrMoW9-1-1		NZ4				CRV2
1.3343	C 0,9; Cr 4,1; Mo 5; V 1,8; W 6,4	M 2	19830	S600	S 6-5-2	AS 6-5-2	SW7M	R6M5	BM 2	F550A	BRM2
1.3344	C 1,21; Cr 4,1; Mo 5; V 2,9; W 6,4	M 3		S607	S 6-5-3	S 6-5-3					
1.3355	C 0,75; Cr 4,1; V 1,1; W 18	T 1	19824	S200	S 18-0-1	HS 18-0-1	SW18	R18	BT 1	F5530	
1.3247	C 1,1; Cr 3,9; Mo 9,2; V 1,2; W 1,4; Co8	M 42		S500	S 2-10-1-8	HS 2-9-1-8	SK8M		BM 42	F5617	
1.2550	C 0,63; Si 0,6; Mn 0,3; Cr 1,1; V 0,18; W 2	S 1	19733	K455	60WCv7	55WC20	NZ3	6ChW2F		F5242	
1.7102	C 0,55; Si 1,45; Mn 0,65; Cr 0,6		14260		54SiCr6						54SiCr6

Gyalugépkések, rovátkolt maróblanketták



Ipari kések

Gyalugépkések

Alapanyag: HSS 6%W - 1.3343 - M2, HSS 18% W - 1.3355 - T1, HLS 13% Cr - 1.2379 - D2, DS - 1.2067 - szerszámacél

Felhasználás: természetes faanyagok megmunkálása

Géptípus: vastagoló gyalugépek és többfejes gyalugépek

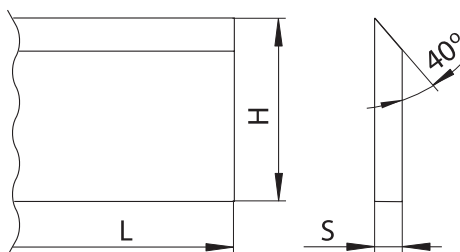

Jellemzők:

- » alapanyag: 1.3355 kemény fára, 1.3343 kemény és puha fára, 1.2379 puha fára, 1.2067 puha fára
- » a gyalugépkések metrikus és angolszáz mértékegység méretben is készülnek
- » a felületkezelt gyalugépkések külön megrendelésre készülnek. Élettartamuk akár megkétszereződhet.
- » a gyalugépkések keménysége 59 és 64 HRC között változhat
- » a hőkezelés speciális, számítógéppel vezérelt kemencékben történik.
- » megrendelésre szabadon választható méretben készülnek

Leggyakrabban használt gyalugépkések – mérettáblázat

[L x H x S]					
100x35x3.0	100x30x3.0	100x25x3.0	100x20x3.0	100x25x2.5	100x20x2.5
120x35x3.0	120x30x3.0	120x25x3.0	120x20x3.0	120x25x2.5	120x20x2.5
130x35x3.0	130x30x3.0	130x25x3.0	130x20x3.0	130x25x2.5	130x20x2.5
150x35x3.0	150x30x3.0	150x25x3.0	150x20x3.0	150x25x2.5	150x20x2.5
180x35x3.0	180x30x3.0	180x25x3.0	180x20x3.0	180x25x2.5	180x20x2.5
210x35x3.0	210x30x3.0	210x25x3.0	210x20x3.0	210x25x2.5	210x20x2.5
240x35x3.0	240x30x3.0	240x25x3.0	240x20x3.0	240x25x2.5	240x20x2.5
260x35x3.0	260x30x3.0	260x25x3.0	260x20x3.0	260x25x2.5	260x20x2.5
310x35x3.0	310x30x3.0	310x25x3.0	310x20x3.0	310x25x2.5	310x20x2.5
400x35x3.0	400x30x3.0	400x25x3.0	400x20x3.0	400x25x2.5	400x20x2.5
410x35x3.0	410x30x3.0	410x25x3.0	410x20x3.0	410x25x2.5	410x20x2.5
450x35x3.0	450x30x3.0	450x25x3.0	450x20x3.0	450x25x2.5	450x20x2.5
500x35x3.0	500x30x3.0	500x25x3.0	500x20x3.0	500x25x2.5	500x20x2.5
510x35x3.0	510x30x3.0	510x25x3.0	510x20x3.0	510x25x2.5	510x20x2.5
530x35x3.0	530x30x3.0	530x25x3.0	530x20x3.0	530x25x2.5	530x20x2.5
610x35x3.0	610x30x3.0	610x25x3.0	610x20x3.0	610x25x2.5	610x20x2.5
640x35x3.0	640x30x3.0	640x25x3.0	640x20x3.0	640x25x2.5	640x20x2.5
710x35x3.0	710x30x3.0	710x25x3.0	710x20x3.0	710x25x2.5	710x20x2.5
810x35x3.0	810x30x3.0	810x25x3.0	810x20x3.0	810x25x2.5	810x20x2.5
910x35x3.0	910x30x3.0	910x25x3.0	910x20x3.0	910x25x2.5	910x20x2.5
1000x35x3.0	1000x30x3.0	1000x25x3.0	1000x20x3.0	1000x25x2.5	1000x20x2.5
1010x35x3.0	1010x30x3.0	1010x25x3.0	1010x20x3.0	1010x25x2.5	1010x20x2.5
1050x35x3.0	1050x30x3.0	1050x25x3.0	1050x20x3.0	1050x25x2.5	1050x20x2.5
1220x35x3.0	1220x30x3.0	1220x25x3.0	1220x20x3.0	1220x25x2.5	1220x20x2.5

Rovátkolt maróblanketták

Alapanyag: HSS 6%W - 1.3343 – M2, HSS 18% W - 1.3355 – T1, HLS 13% Cr - 1.2379 – D2

Felhasználás: profilmarás, deszkák és fahasábok marása

Géptípus: alsó marók, többoldalú profilmarók, egyengető és vastagsági gyalugépek



Jellemzők:

- » Alapanyag: 1.3355 kemény fára, 1.3343 kemény és puha fára, 1.2379 puha fára
- » a maróblanketták metrikus és angolszáz mértékegység méretben készülnek
- » megrendelésre szabadon választható méretben készülnek
- » a maróblanketták keménysége 58 és 63 HRC között változik, megrendelése más keménységet is biztosítunk
- » a hőkezelés speciális, számítógéppel vezérelt kemencékben történik
- » köszörült rovátkolás: 60 és 90
- » élszög: standard 45 + fazetta 0,5 mm, egyéb élszög megrendelésre
- » oldalszög 45, egyéb oldalszög megrendelésre

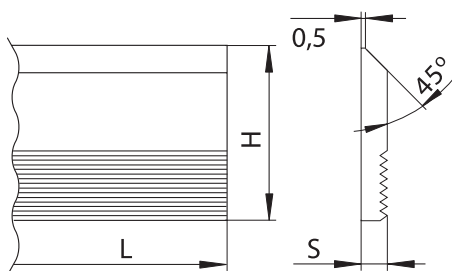

Leggyakrabban használatos rovátkolt maróblanketták – mérettáblázat

[L x H x S]								
30x50x8	30x60x8	30x40x8	30x80x8	30x40x6	30x50x6	30x60x6	30x30x4	30x40x4
40x50x8	40x60x8	40x40x8	40x80x8	40x40x6	40x50x6	40x60x6	40x30x4	40x40x4
50x50x8	50x60x8	50x40x8	50x80x8	50x40x6	50x50x6	50x60x6	50x30x4	50x40x4
60x50x8	60x60x8	60x40x8	60x80x8	60x40x6	60x50x6	60x60x6	60x30x4	60x40x4
70x50x8	70x60x8	70x70x8	70x80x8	70x40x6	70x50x6	70x60x6	70x30x4	70x40x4
80x50x8	80x60x8	80x70x8	80x80x8	80x40x6	80x50x6	80x60x6	80x30x4	80x40x4
100x50x8	100x60x8	100x70x8	100x80x8	100x40x6	100x50x6	100x60x6	100x30x4	100x40x4
130x50x8	130x60x8	130x70x8	130x80x8	130x40x6	130x50x6	130x60x6	130x30x4	130x40x4
150x50x8	150x60x8	150x70x8	150x80x8	150x40x6	150x50x6	150x60x6	150x30x4	150x40x4
180x50x8	180x60x8	180x70x8	180x80x8	180x40x6	180x50x6	180x60x6	180x30x4	180x40x4
210x50x8	210x60x8	210x70x8	210x80x8	210x40x6	210x50x6	210x60x6	210x30x4	210x40x4
230x50x8	230x60x8	230x70x8	230x80x8	230x40x6	230x50x6	230x60x6	230x30x4	230x40x4
260x50x8	260x60x8	260x70x8	260x80x8	260x40x6	260x50x6	260x60x6	260x30x4	260x40x4
500x50x8	500x60x8	500x70x8	500x80x8	500x40x6	500x50x6	500x60x6	500x30x4	500x40x4
600x50x8	600x60x8	600x70x8	600x80x8	600x40x6	600x50x6	600x60x6	600x30x4	600x40x4
635x50x8	635x60x8	635x70x8	635x80x8	635x40x6	635x50x6	635x60x6	635x30x4	635x40x4
650x50x8	650x60x8	650x70x8	650x80x8	650x40x6	650x50x6	650x60x6	650x30x4	650x40x4

Ipari kések

Keményfémlapkás gyalugépkések

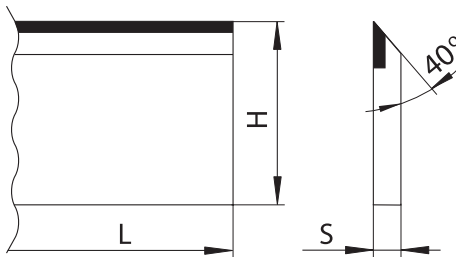

- Alapanyag:** nagyszilárdságú keményfém, megfelelő tartóssággal speciálisan fa alapanyagok megmunkálására
- Felhasználás:** kemény fa anyagok egyengetése és vastagítása, ragasztott falemezek megmunkálása, jó minőségű gyalulás
- Géptípus:** egyengető és vastagoló gépek

Jellemzők:

- » a keményfémlapkás gyalugépkések acél alaptestéhez ezüst-réz bázisú forrasztással rögzítik a keményfémlapkákat
- » a gyalugépkések metrikus és angolszáz mértékegység méretben készülnek
- » megrendelésre szabadon választható méretben készülnek

Leggyakrabban használatos keményfémlapkás gyalugépkések – mérettáblázat

[L x H x S]					
100x35x3.0	310x35x3.0	810x35x3.0	210x30x3.0	500x30x3.0	1050x30x3.0
120x35x3.0	400x35x3.0	1050x35x3.0	240x30x3.0	510x30x3.0	180x25x3.0
130x35x3.0	410x35x3.0	100x30x3.0	260x30x3.0	530x30x3.0	210x25x3.0
150x35x3.0	510x35x3.0	120x30x3.0	310x30x3.0	610x30x3.0	260x25x3.0
180x35x3.0	530x35x3.0	130x30x3.0	400x30x3.0	640x30x3.0	310x25x3.0
210x35x3.0	610x35x3.0	150x30x3.0	410x30x3.0	710x30x3.0	810x25x3.0
240x35x3.0	640x35x3.0	180x30x3.0	450x30x3.0	810x30x3.0	1050x25x3.0

Keményfémlapkás rovátkolt maróblanketták

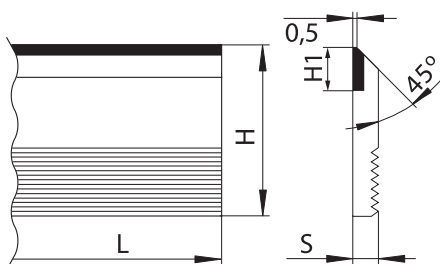

- Alapanyag:** nagyteljesítményű kemény fém speciálisan fa alapanyagok megmunkálására
- Felhasználás:** profilmarás, deszkák és fahasábok forgácsolása
- Géptípus:** alsó marók, többfejes profilmarók, egyengető és vastagoló gyalugépek

Jellemzők:

- » a maróblanketták szerszámacél alaptestéhez ezüst-réz bázisú forrasztással rögzítik a keményfémlapkákat.
- » a maróblanketták metrikus és angolszáz mértékegység méretben készülnek
- » a H1 keményfémlapkák szélessége : 15,20,25,30
- » megrendelésre egyéb méretekben is készülnek

Leggyakrabban használt keményfémlapkás maróblanketták – mérettáblázat

[L x H x S]			
50x40x8	50x50x8	50x60x8	50x70x8
80x40x8	80x50x8	80x60x8	80x70x8
100x40x8	100x50x8	100x60x8	100x70x8
130x40x8	130x50x8	130x60x8	130x70x8
180x40x8	180x50x8	180x60x8	180x70x8
230x40x8	230x50x8	230x60x8	230x70x8
650x40x8	650x50x8	650x60x8	650x70x8

Aprítógépkések faforgácslapokhoz

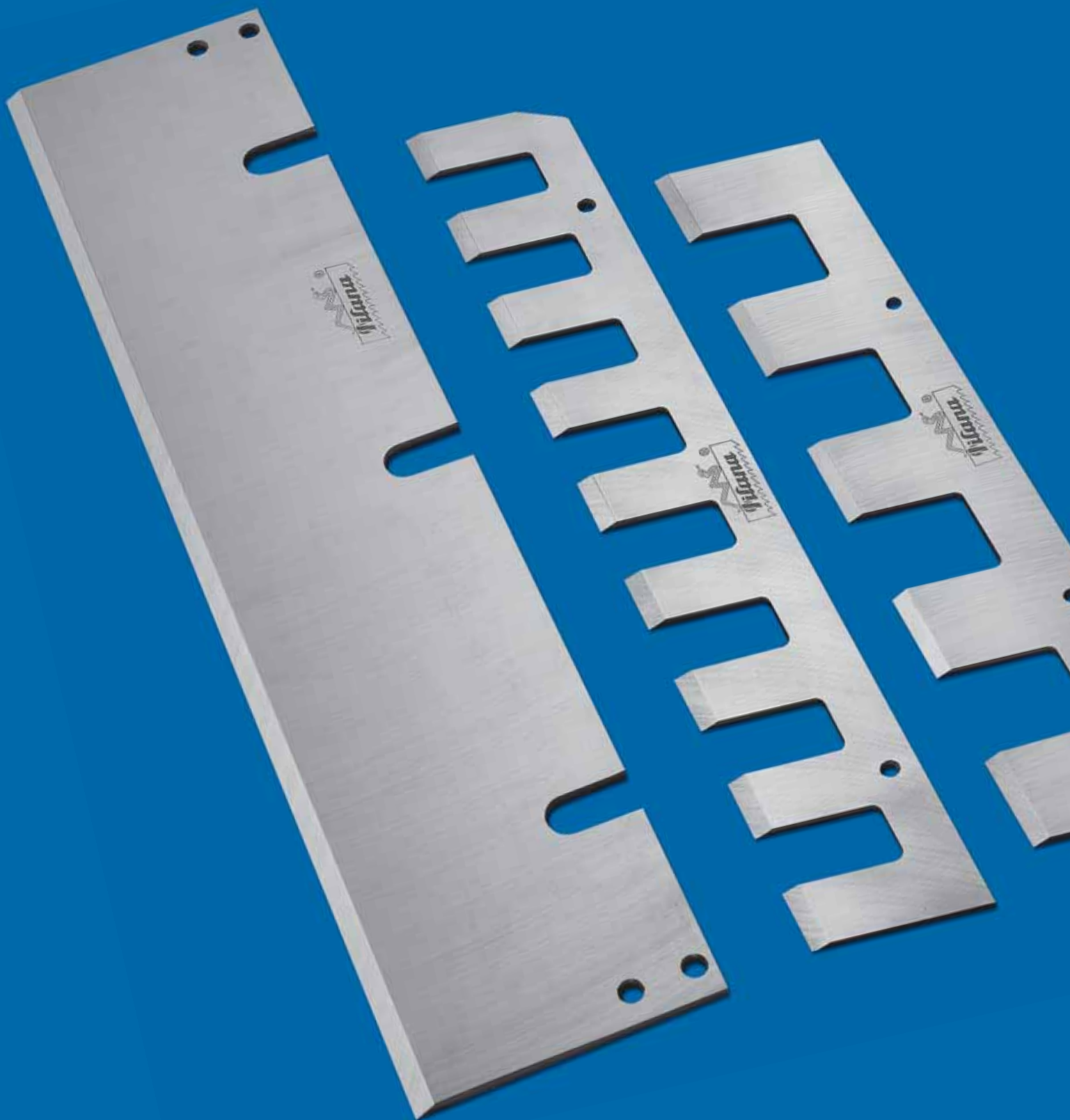

Aprítógépkések faforgácslapokhoz



- Alapanyag:** speciális chipper acél faforgácslapok aprításához
- Felhasználás:** egyfázisú és kétfázisú faforgácslapgyártás végső műveletéhez
- Géptípus:** Pallmann, Maier, Klöckner, Pessa aprítógépek és első munkafázishoz Hombak gépekhez

Jellemzők:

- » aprítókések 55 és 57 HRC keménység között, megrendelésre egyéb keménységgel
- » a hőkezelés speciális, számítógéppel vezérelt kemencékben történik
- » élszög: 35 –44 géptípustól függően

Leggyakoribb aprítógépkések – méretábrázolás

[L x H x S]				
Hombak	Klöckner	Maier	Pallmann	Pessa
306,9x57x4	403x90x4	334x100x5	299x100x5	599x100x5
363,1x57x4	489x90x4	464x100x5	449x100x5	
365,6x75x4	501x90x4	464x90x5	524x100x5	
370,2x57x4			449x90x5	
525,5x62x4			449x85x3	
533,4x75x4			299x75x5	
539,3x57x4			449x90x3	
547,3x74x4				

Aprítógépkések OSB anyagra



- Alapanyag:** speciális chipper acél, aprító és örlőkésekre kifejlesztve
- Felhasználás:** OSB lapok gyártásának első munkafázisához
- Géptípus:** Pallman, Maier, Klöckner és CAE

Jellemzők:

- » keménység 55 –58 HRC között, megrendelésre egyéb keménységgel
- » a hőkezelés speciális, számítógéppel vezérelt kemencékben történik

Leggyakoribb aprítógépkések – méretábrázolás

[L x H x S]	
CAE	Pallmann
469,9x69,85x5	603x83x5
726,85x82,5x6,35	680x83x5
	728x83x5
	803x83x5

Aprítógépek faforgácslapokhoz

BEZNER

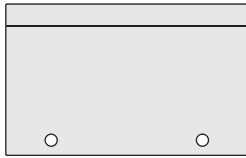

80 x 50 x 5

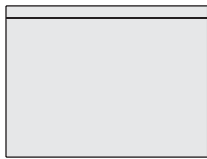

80 x 60 x 5

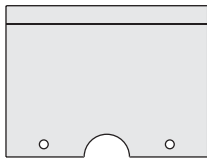

80 x 60 x 5

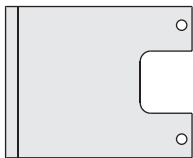

90 x 73 x 4

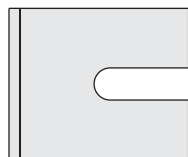

95 x 80 x 5

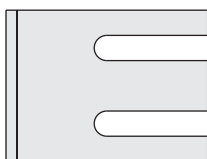

160 x 120 x 6

BEZNER

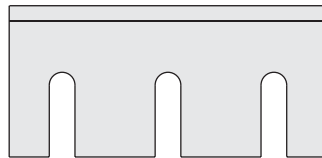

210 x 100 x 10

CAE



469 x 69,8 x 5

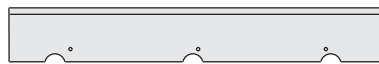

470 x 67 x 5

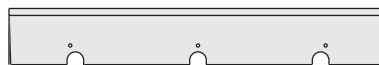

470 x 69,8 x 5

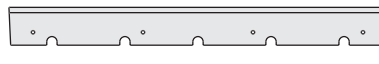

698,5 x 69,85 x 5

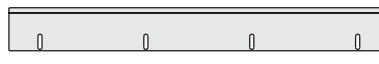

725,5 x 82,55 x 6,35

HOMBAK

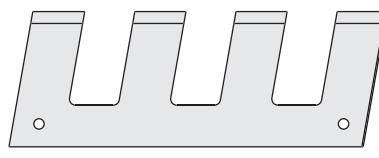

180 x 65 x 4

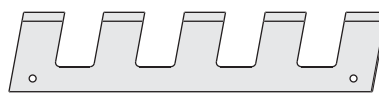

271 x 57 x 4

HOMBAK



297 x 57 x 4

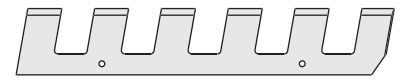

325 x 57 x 4

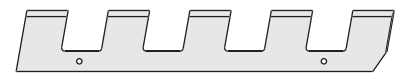

353 x 57 x 4



355 x 74 x 4



363 x 57 x 4



370 x 57 x 4

JENZ

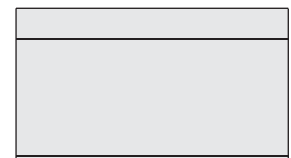

108 x 50 x 5

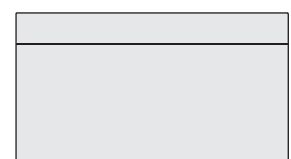

108 x 60 x 7

Aprítógépkések faforgácslapokhoz

KLÖCKNER



412 x 90 x 4



488 x 93 x 4

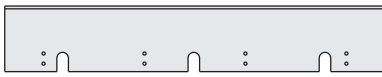

490 x 85 x 3,5

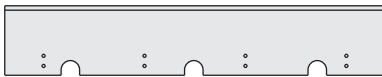

490 x 90 x 4

MAIER

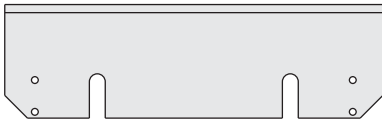

333 x 100 x 5



334 x 100 x 5



348 x 66 x 5



464 x 90 x 5

MAIER

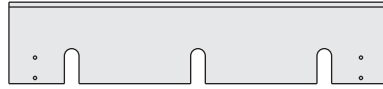

464 x 100 x 5

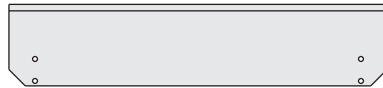

464 x 100 x 6

PALLMANN

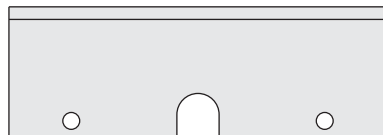

179 x 61 x 5

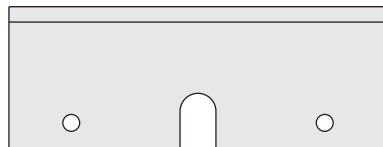

179 x 67 x 5

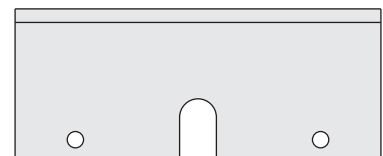

179 x 74 x 5



299 x 55 x 6



299 x 75 x 5

PALLMANN

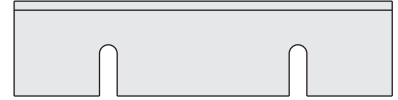

299 x 75 x 5

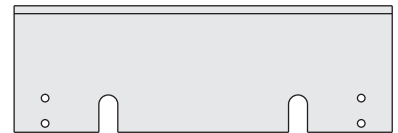

299 x 100 x 5

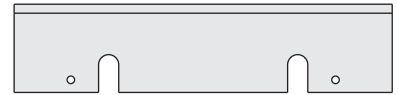

300 x 70 x 5



334 x 100 x 6,35

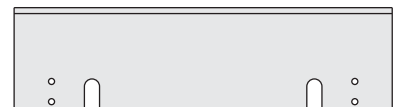

374 x 100 x 5



449 x 75 x 5



449 x 85 x 3



449 x 89 x 5

Aprítógépekések faforgácslapokhoz

PALLMANN

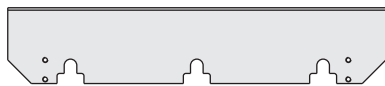

449 x 90 x 3

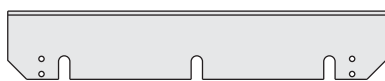

449 x 90 x 5



449 x 90 x 5



449 x 90 x 5



449 x 95 x 3



449 x 99 x 5



449 x 100 x 5



449 x 100 x 5

PALLMANN



450 x 95 x 3



501 x 90 x 4

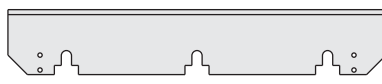

524 x 90 x 5



524 x 100 x 5



598 x 85 x 5



599 x 75 x 5



603 x 83 x 5



678 x 83 x 5



680 x 83 x 5

PALLMANN

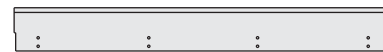

728 x 83 x 5



803 x 83 x 5

PESSA



559 x 100 x 5



598 x 100 x 5



652,8 x 75 x 5

Ipari kések

Gyűrűs aprítógépés tartozékok

Alapanyag:	speciális chipper acél, aprító és örlőkésekre kifejlesztve, szerszámacél
Felhasználás:	két vagy egyfázisú faforgácslap gyártás befejező munkafázisa
Géptípus:	gyűrűs aprítógépek, pld: Pallmann, Maier, Klöckner, Pessa, Hombak

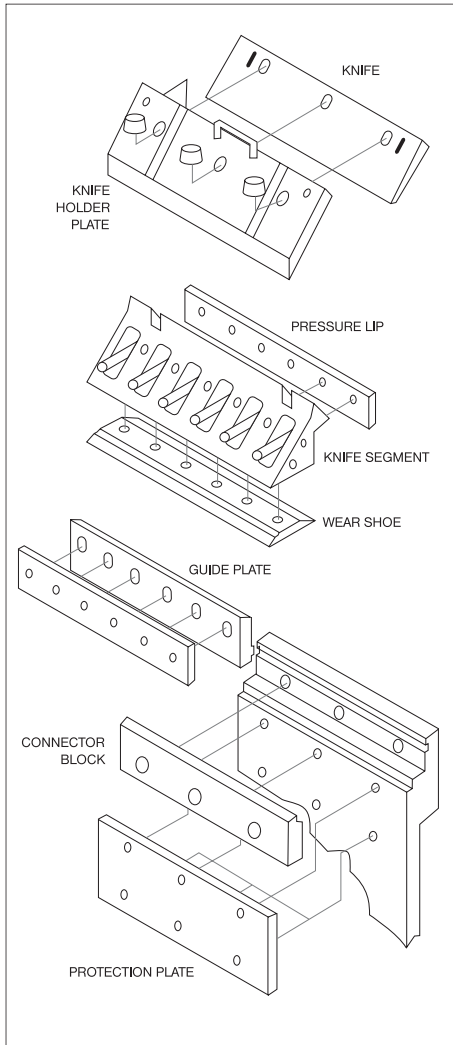

Gyártjuk:

- » kések
- » felfogó
- » nyomólap
- » kés szegmens
- » szorító lap
- » vezető sín
- » szorító lécs
- » összekötő blokk
- » takaró lécs

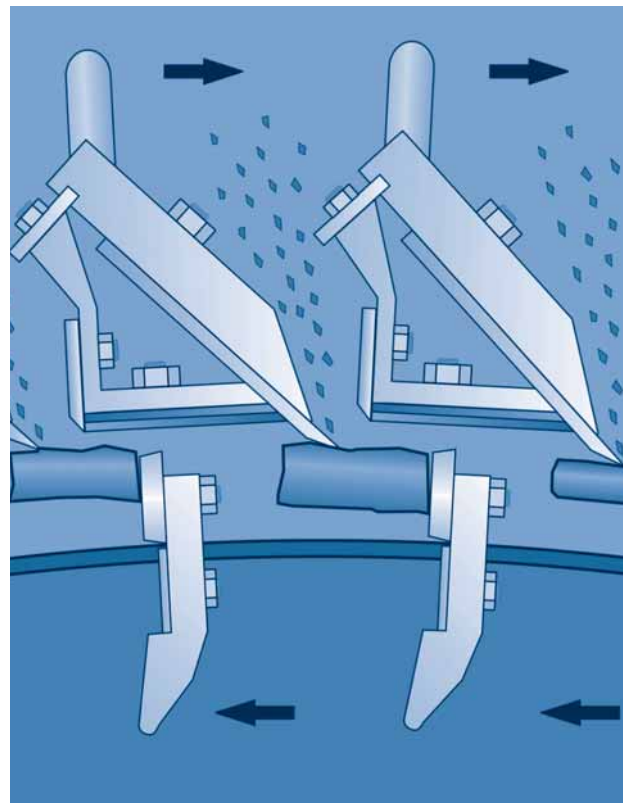

Daráló kések



Ipari kések

Daráló kések

Alapanyag: speciális chipper acél, aprító és daráló késekre kifejlesztve

Felhasználás: hulladékfa aprítás, forgács gyártás

Géptípus: daráló kések

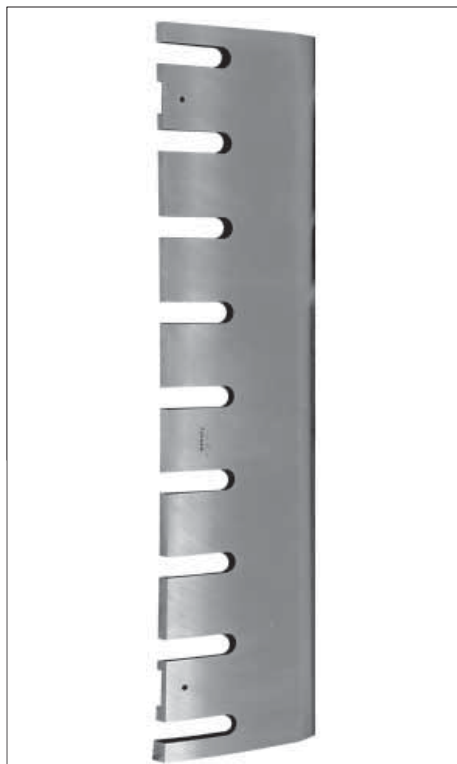

Jellemzők:

- » daráló kések 52 és 58 HRC között
- » a hőkezelés speciális, számítógéppel vezérelt kemencékben történik
- » élszög: 26 és 40 géptípustól és a felhasznált faanyagtól függően
- » bármilyen kés gyártása adott dokumentáció vagy minta alapján
- » a kések mellett még szállítunk ellenkéseket, nyomólapokat és egyéb elemeket

Az alábbi géptípusokhoz gyártunk késeket

Ahlstrom	Brush	Erjo	Jenz	Murray	Rudnick
Altec	Bush	Esterer	Klöckner	Murray	Segem
Ari	Camura	Ferrari	KMW	NHS	Schlising
Asplundh	Canadac	Fujikogio	Kockum	Nicolson	Siba
Bandit	Candac	Fulghum	Kone Wood	Olathe	Sjolins
Berkli	Carthage	Gustin Som	LGU	Pallmann	Tunissen
Bezner	Comact	Hedlund	Linder	Pessa	Vecoplan
Blaf Clawson	Demuth	Heinola	Maier	Pezzolato	Vermeer
Bongioann	Dosco	Husky	Mitts	Precision	Wayne
Bruks	Ducker	Jensen	Morbark	Rauma	Zeno

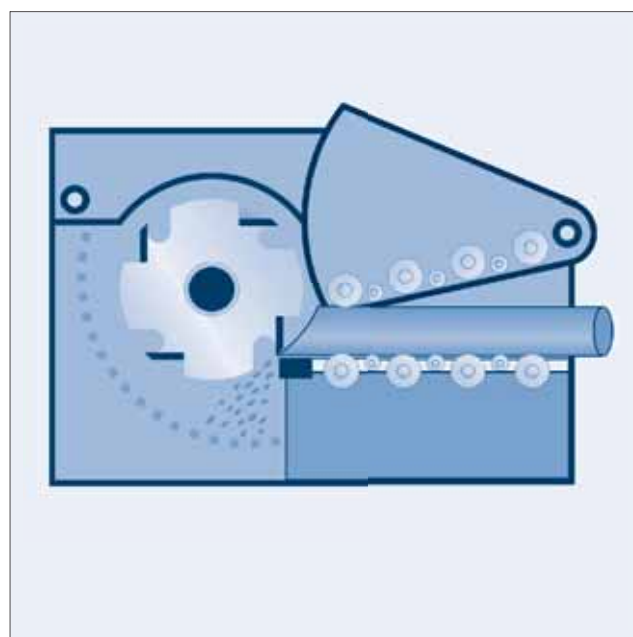
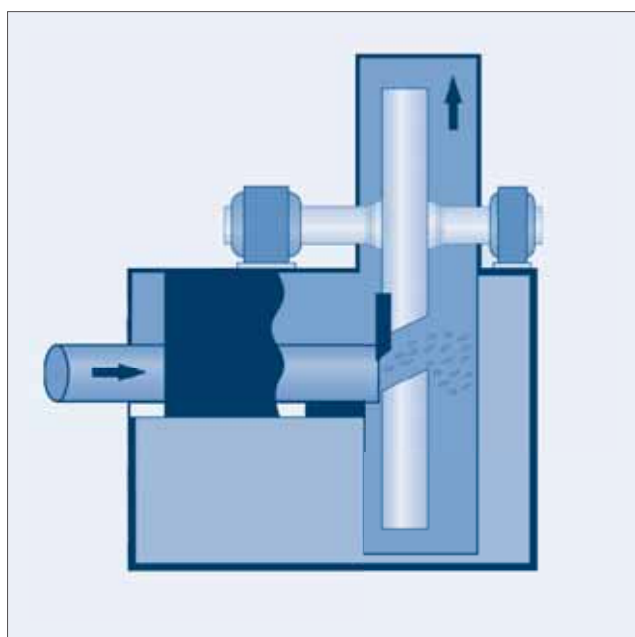

Daráló kések

ARI

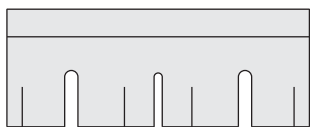

296 x 118 x 16



630 x 150 x 12

BANDIT

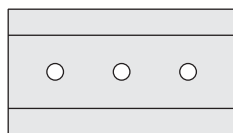

184 x 101,6 x 12,7

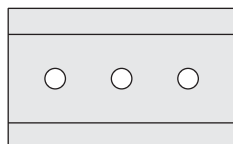

184 x 114 x 12,7

BLACK CLAWSON

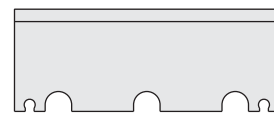

380 x 147 x 12,7

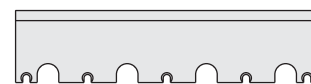

533 x 127 x 9,5

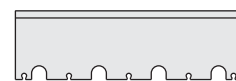

578 x 175 x 12,7



610 x 173 x 12,7

ASPLUNDH / ALTEC



305 x 76,2 x 9,5



406 x 76,2 x 9,5

BELOIT

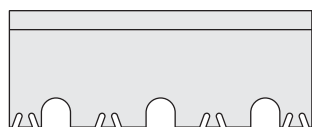

330 x 127 x 12,7

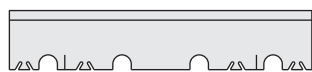

520 x 101,6 x 9,5

BANDIT

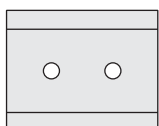

127 x 101,6 x 9,5

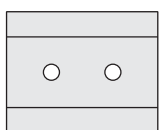

127 x 101,6 x 12,7

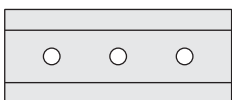

184 x 76,2 x 12,7

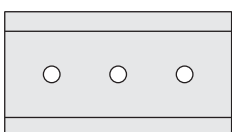

184 x 101,6 x 9,5

BEZNER

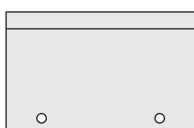

80 x 50 x 5

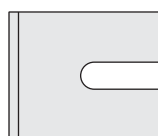

80 x 95 x 5

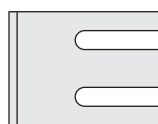

120 x 160 x 6

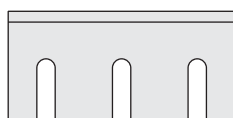

210 x 100 x 10

BONGIANI

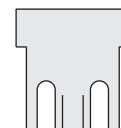

66 x 70 x 10

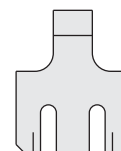

93 x 120 x 15 S

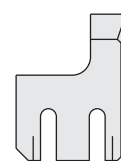

93 x 120 x 15 L

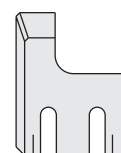

93 x 120 x 15 P

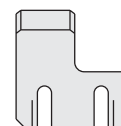

120 x 125 x 15 L

Daráló kések

BLACK CLAWSON

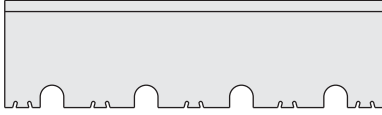

610x173x12,7
Model: 153"

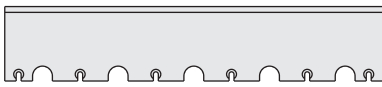

762x150x13
Model: 96"

BRODBAECK

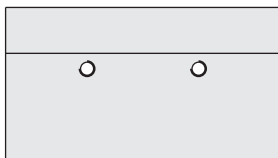

210,5x116x22

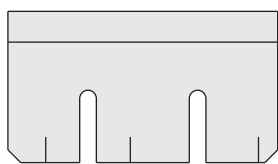

210,5x118x15

BRUKS

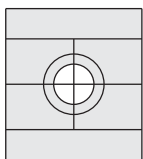

60x54x40
Model: 700,1

BRUKS

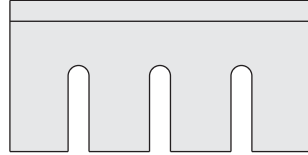

258x130x10

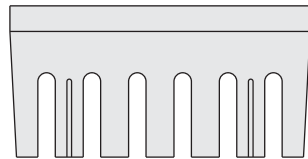

258x130x12

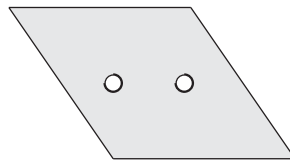

282x149x13



300x130x12
Model: 250S,250T K 300

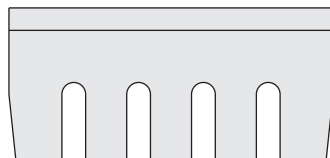

300x140x12

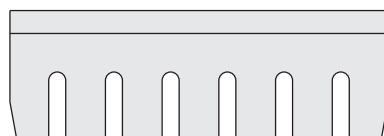

400x135x14
Model: 1200AH,1200M,1300,1700AH

BRUKS

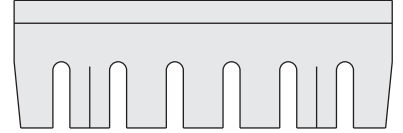

400x135x14
Model: 1200AH,1200M,1300,1700AH

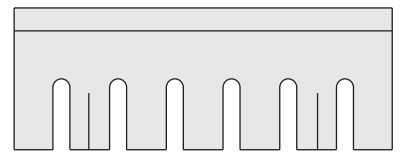

400x150x14

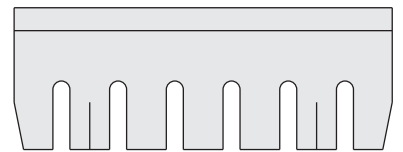

400x150x14

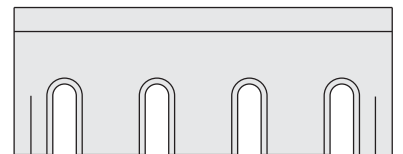

450x175x20
Model: 1500R

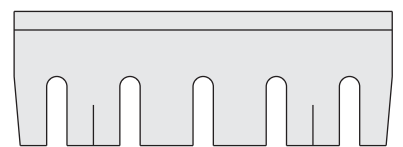

465x165x16
Model: 1500AH,1500M,1502M

Daráló kések

BRUKS

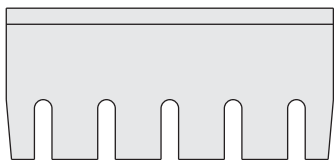

465x215x16
Model: 1500AH,1500M,1502M



520x170x16



525x180x16
Model: 1700,1701,1702,1703,2000

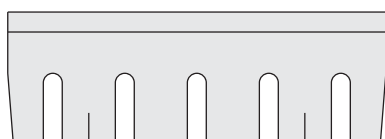

525x180x16
Model: 1700,1701,1702,1703,2000

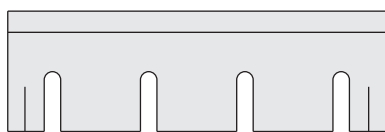

550x175x20
Model: 800 cCS,800CM,800CMT

BRUKS

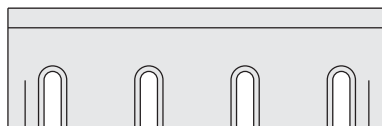

550x175x20
Model: 802,800,803CS/CM,812CS

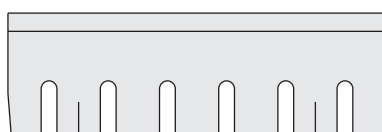

575x185x15/16
Model: 800CT,1000CT,820CS

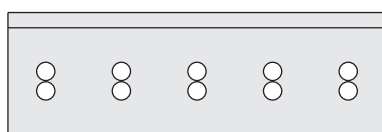

620x200x20



620x225x20
Model: 2100AH,2100M



705x180x16
Model: 1202,1203CS/CM,1212CS



800x180x16

BRUKS

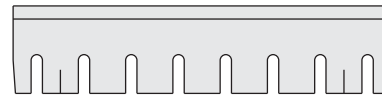

800x185x15/16
Model: 1001CT,803CT

BUSH

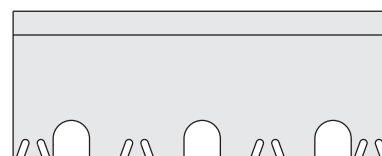

330x127x12,7



457,2x101,6x9,5
Model: 60"



520x101,6x9,5



520,7x54x9,5
Model: 66"



711,2x127x12,7
Model: 96"

Daráló kések

CAE

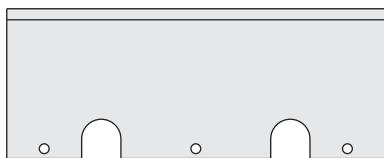

308x122x9,5



480x122x9,5



482,6x122x9,5

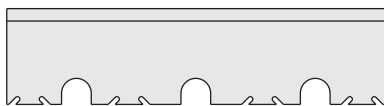

482,6x122,2x9,5
Model: 55"

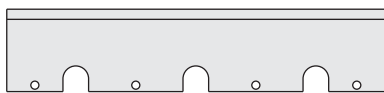

560x122x9,5

CANADAC



275x100x12

CANADAC

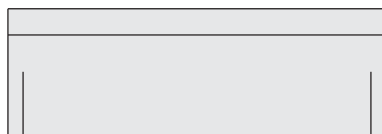

300x100x12

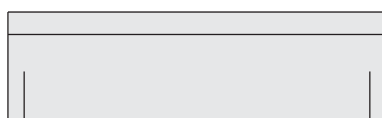

350x100x12

CAPITAL

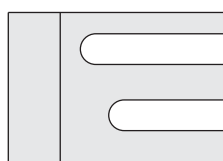

146,1x101,6x12,7

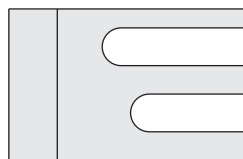

158,8x101,6x15,9

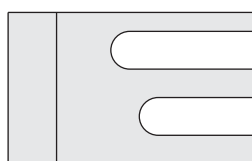

165,1x101,6x15,9

CARTHAGE



520,7x165x19
Model: 140"



609,6x127x12,7



609,6x152,4x12,7
Model: 84"



685,8x127x17,5



685,8x165,1x12,7
Model: 27"

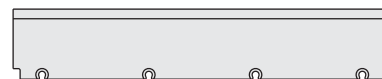

686x127x12,7
Model: 104



757,2x152,4x12,7
Model: 104

Daráló kések

CARTHAGE

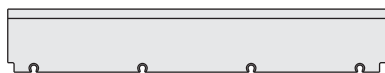

762x127x12,7



762x165x12,7
Model: 112"

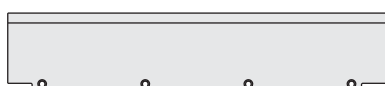

838x165x16

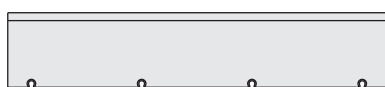

838,2x165,1x12,7
Model: 33"

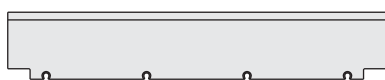

860x152x12,7

CUMBERLAND

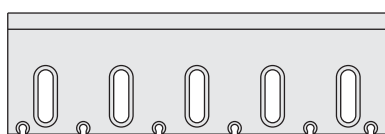

634,6x203,2x20,5

DEMUTH



540x140x16

DIEMER

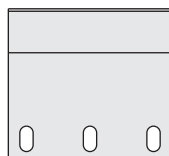

270x250x15

ERJO

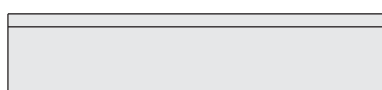

350x75x10



450x125x11/12
Model: 200SN,202,204,600MA

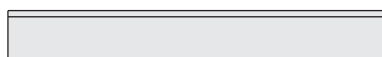

550x75x10



550x125x11/12
Model: 60-552,60-554,120-154



550x135x12

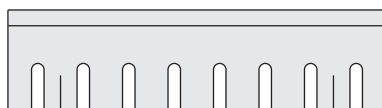

665x175x15/16

ERJO



665x175x15/16

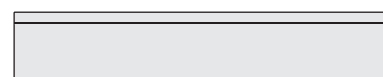

700x125x11/12



700x125x12
Model: 60-702,60-704,120-706

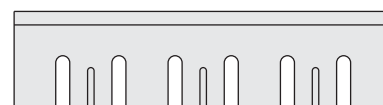

700x175x15/16



800x185x15/16

FERRARI

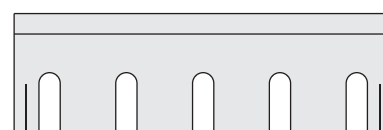

320x100x10
Model: PS T3

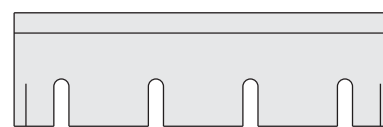

400x120x15

Daráló kések

FERRARI

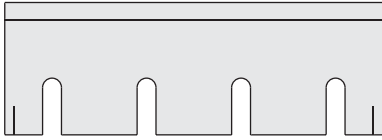

400x140x15

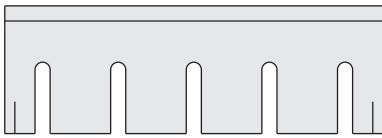

450x152x20
Model: L5T2



620x152x20
Model: L6T2

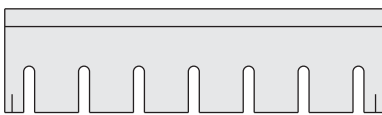

620x170x20

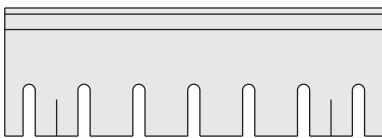

620x210x20
Model: L8T2



920x152x20
Model: L7T2

FERRARI

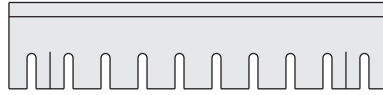

920x210x20
Model: L11T3

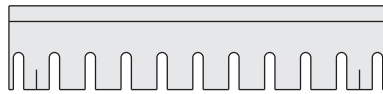

948x210x20

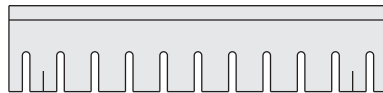

1100x250x25

FICHTBURG

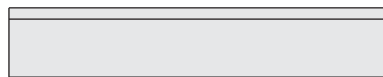

381x69,8x9,5

FORANO

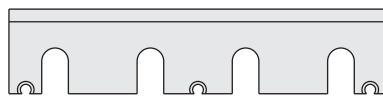

454x101,6x9,5
Model: 58"

FUJI KOGYO

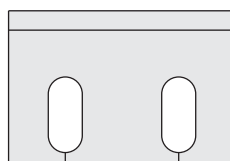

240x160x16

FUJI KOGYO

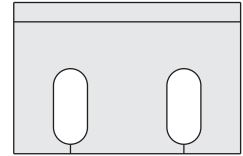

240x160x16



430x200x16

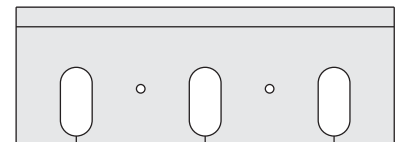

440x160x16

FULGHUM

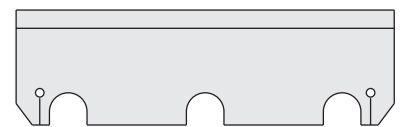

352x107x9,8



355x91x9,5
Model: 48"

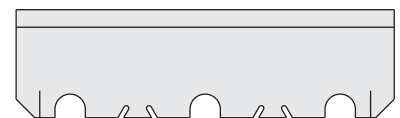

355,6x101,6x9,5
Model: 48"

Daráló kések

FULGHUM

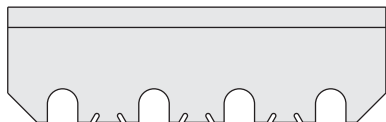

394x120x12,7
Model: 96"

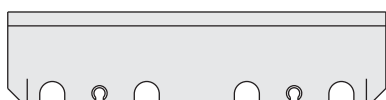

431,8x101,6x9,5
Model: 54"



489x101,6x9,5
Model: 60"



489x101,6x9,5
Model: 60"



489x101,6x9,5
Model: 60"



546x101,6x9,5
Model: 66"

FULGHUM

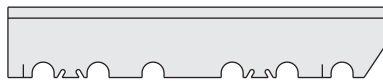

546,1x101,6x9,5
Model: 66"

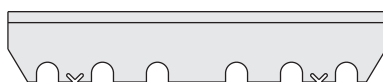

546,1x101,6x9,5
Model: 66"



609x120,6x12,7



611x68,3x9,5

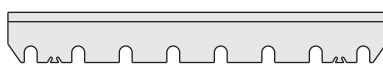

909,6x120,7x12,7
Model: 112"



939,7x120,7x12,7

GUSTIN SOM

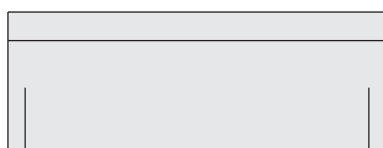

275x100x12

GUSTIN SOM

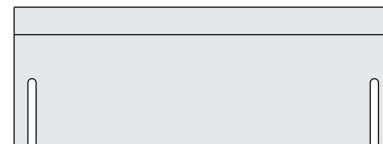

275x100x12

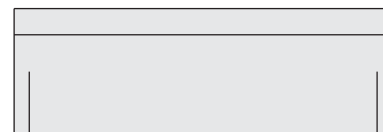

300x100x12

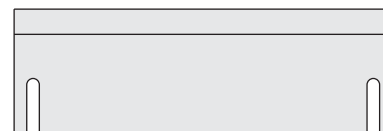

300x100x12

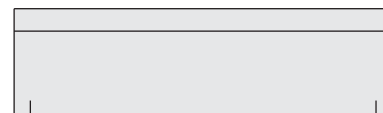

350x100x12

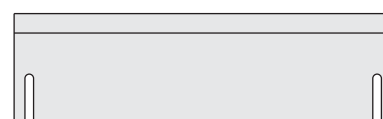

350x100x12

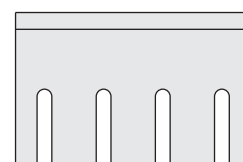

350x225x15

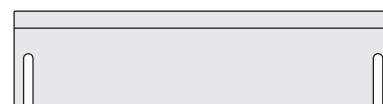

400x100x12

Daráló kések

GUSTIN SOM

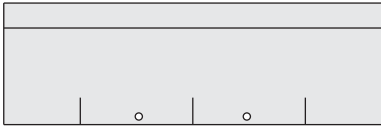

420x135x16

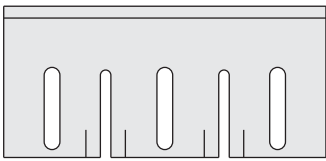

490x230x15

HAAS



530x85x14

HEDLUND

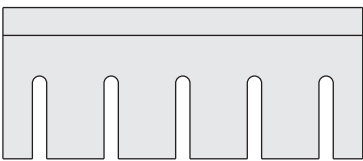

452x190x16

HEINOLA

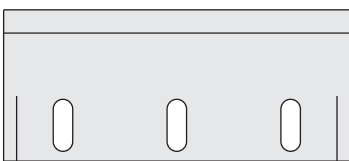

213x93x10
Model: SK 6

HEINOLA

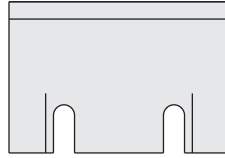

240x165x12



695x100x25



720x60x10

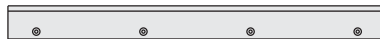

720x64x10



720x160x16
Model: TT97RG



720x165x12



800x75x10



1090x180x16

HEINOLA / AHLSTRÖM

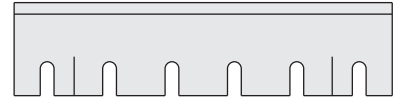

630x155x12
Model: TT75RS

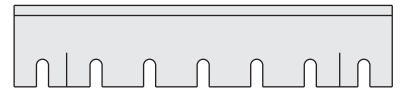

720x155x12

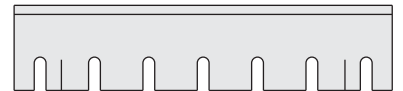

800x180x12

HOLZMATIC

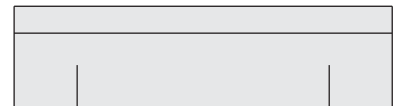

450x120x20

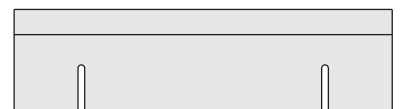

450x120x20

ISLES FORGE

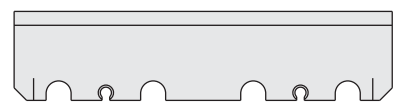

431,8x101,6x9,5
Model: 54"

Daráló kések

ISLES FORGE

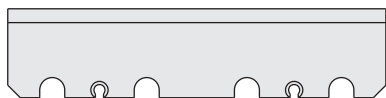

432x101,6x9,5
Model: 54"



495,3x101,6x9,5

JENZ



820x140x20



1024x140x20

KLÖCKNER



530x120x20

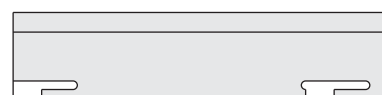

530x120x20

JENZ

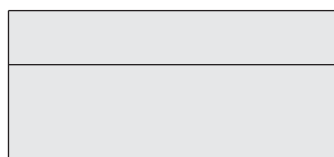

108x50x5

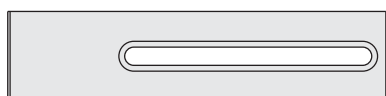

228x54x20



250x54x15



700x120x20
Model: SM 80/70,80/40,120/70



700x140x20

JUNKKARI

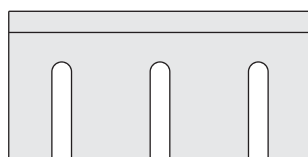

200x100x10

KLÖCKNER

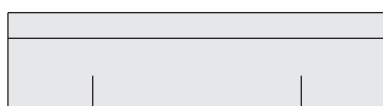

330x85x14
Model: HZM 1/300

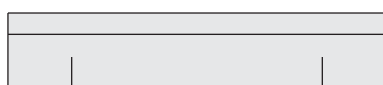

430x85x14
Model: HZM 1/400

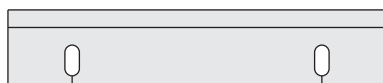

430x90x14



530x85x15



565x280x25



565x280x25

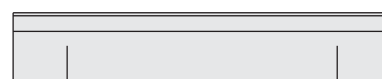

630x120x20



630x190x20

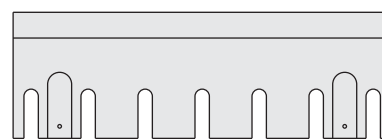

630x210x20

Daráló kések

KLÖCKNER

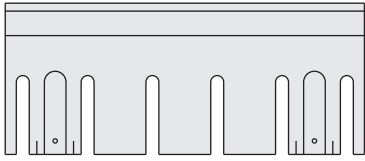

665x280x25

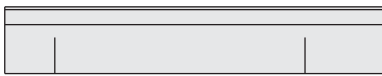

680x120x20



730x85x15



830x120x20

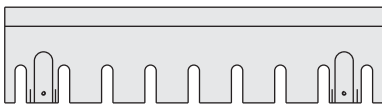

830x210x20

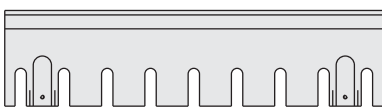

830x210x20



930x120x20



930x210x20

KLÖCKNER

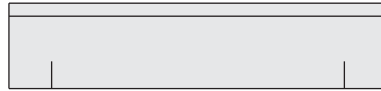

930x210x20



930x210x20



930x210x20

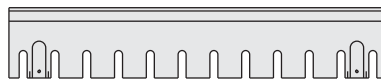

1130x210x20

KONE WOOD

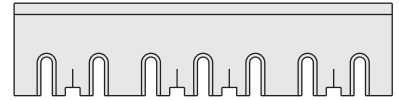

920x225x20

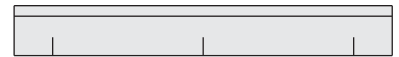

1030x136x15,9

LINDNER

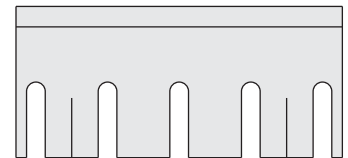

410x190x18

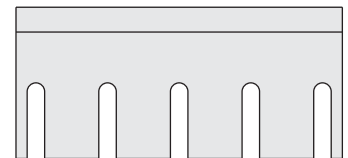

410x190x18

KONE WOOD

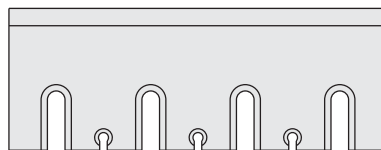

600x225x20

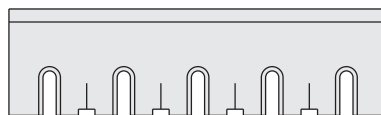

800x225x20

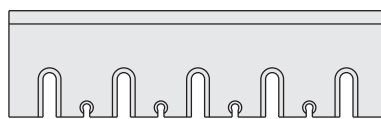

800x225x20

MAIER

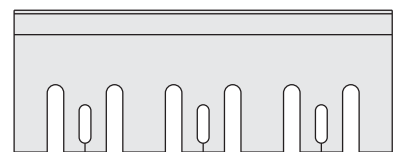

640x240x20

Model: HR 600-1600, HB 600

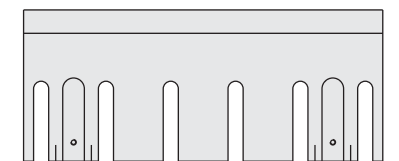

665x280x25

Model: HR 600, HB 600

Daráló kések

MAIER

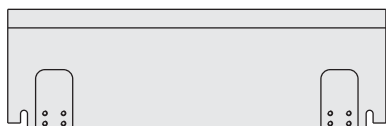

815x260x25
Model: HRL 2000/850x1500



839x241x20
Model: HB 800,HR 600-1600



840x240x20
Model: HB 800,HR 600-1600

MITTS MERRILL

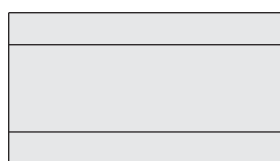

108x60x12,7

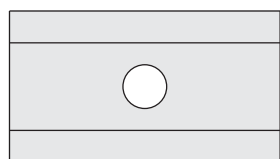

108x60,3x12,7

MORBARK

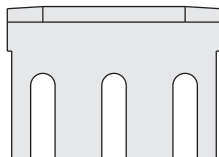

152,4x108x11,1
Model: PS 8

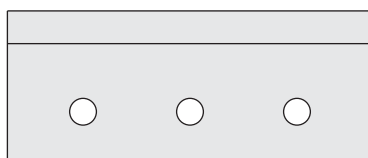

184x76,2x9,5
Model: Eeger Beaver

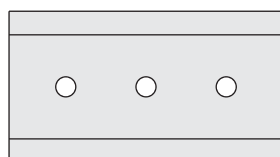

184x101,6x9,5

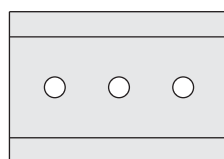

184x127x12,7
Model: 300,490,2100D

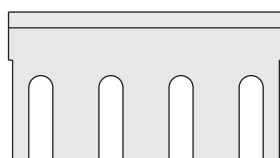

200x110x11,5

MORBARK

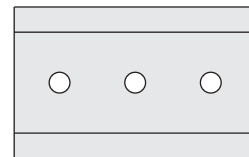

203,2x127x12,7
Model: 2012D

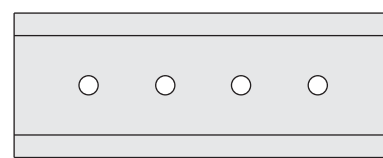

266x101,6x9,5
Model: 175,10/26,10/36

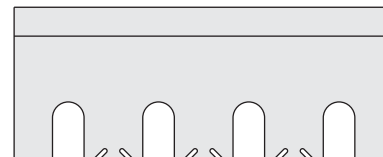

266x106,3x12,7

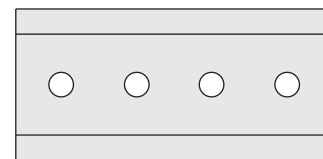

266x127x12,7

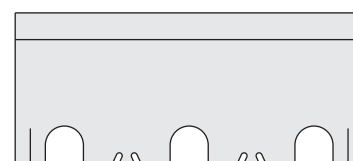

292,2x127x12,7
Model: 75"

Daráló kések

MORBARK



317x76,5x9,5
Model: 38"

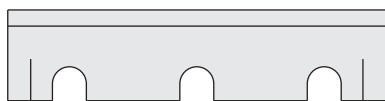

317,5x76,2x9,5
Model: 38"

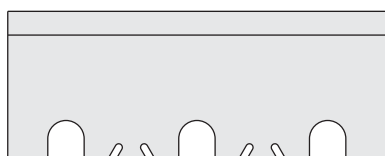

330x127x12,7
Model: 84"

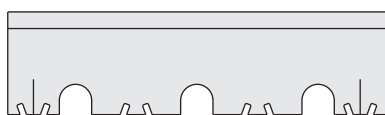

374x101,6x9,5

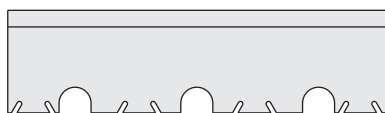

374,7x101,6x9,5

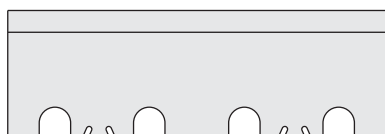

381x127x12,7
Model: 27"

MORBARK

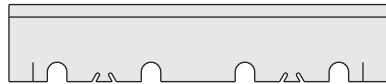

498,5x101,6x9,5
Model: 58"



584x127x12,7

MURRAY



914,4x165,1x15,9

NICHOLSON

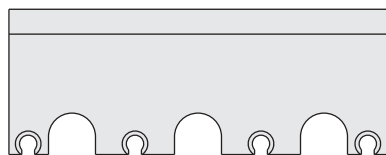

281x108x12,7

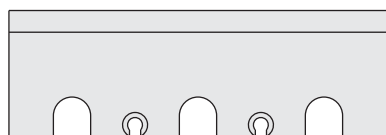

322x108x12,7
Model: 85"



393,6x107,9x12,7
Model: 53"

NICHOLSON



394x76x4,7



457x101,6x9,5
Model: 53"

OLATHE



305x50,8x4,75
Model: 12"

PALLMANN



350x100x20



565x280x25

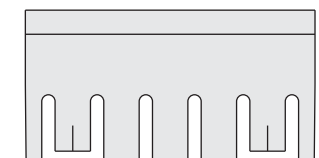

565x295x25
Model: PHT 500x1050

Daráló kések

PALLMANN



570x130x12
Model: PHT 150 S30



630x130x12



630x160x15
Model: 180/500



665x295x25



780x220x20



780x220x20
Model: PHT 400x700



880x180x16

PALLMANN



930x280x25



960x160x15
Model: PHT 80x850



1130x220x25

PESSA

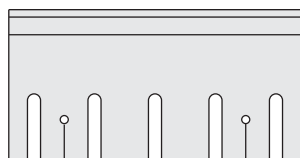

580x300x25



665x300x25
Model: CLM 860x1250/6

PEZZOLATO

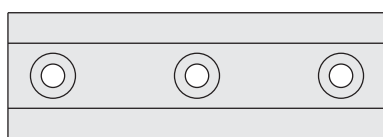

210x70x11

PEZZOLATO



298x150x14

PHL

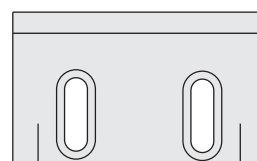

254x152x16

PRECISION



317,5x76x9,5
Model: 38"



374x101,6x9,5
Model: 48"



380,6x73x9,5
Model: 30"



498x101,6x9,5
Model: 58"

Daráló kések

PRECISION

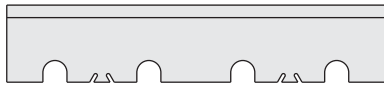

498,5x101,6x9,5
Model: 58"

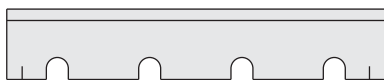

546x101,6x9,5
Model: 66"



546,1x101,6x9,5
Model: 66"



584x127x12,7
Model: 75"



660x127x12,5
Model: 84"



711x127x12,7

RADER



503x101x7

RAUMA



640x141x12,7

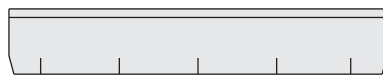

817x141x12,7

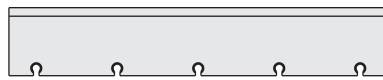

817x147x12,7



917x145x16



917x160x16



939x152x12,7
Model: DS 3300



940x150x12,7
Model: DS 3300

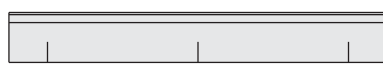

1030x136x15,9

RUDNICK

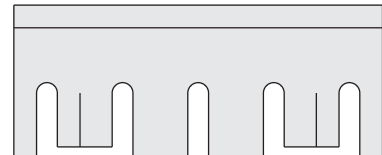

390x160x15

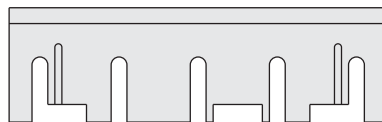

430x130x12



530x130x12

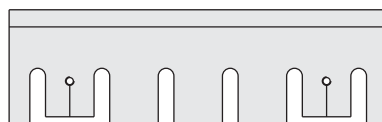

530x160x15



630x130x12



630x160x15
Model: 200/180x500,300x500SH

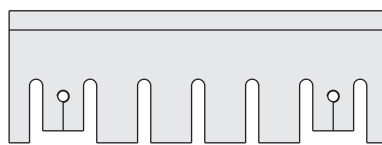

630x220x20

Daráló kések

RUDNICK



680x130x12



780x160x15

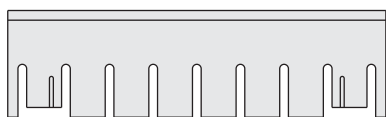

780x220x20

SEGEM

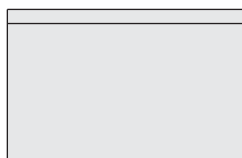

235x150x8

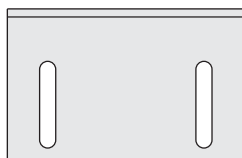

235x150x8

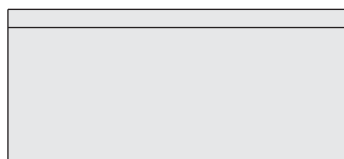

335x150x8

SEGEM

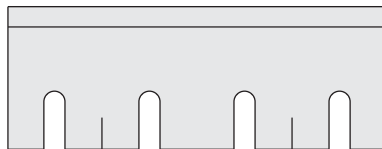

358x135x12

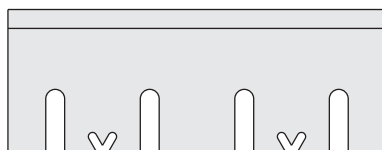

360x135x12

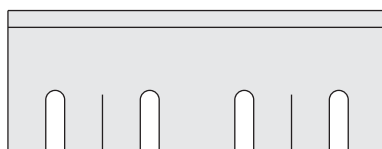

360x135x12

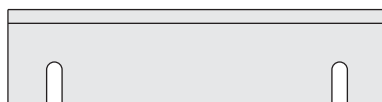

440x110x12

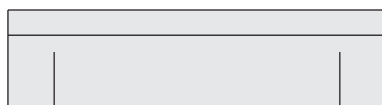

450x120x20

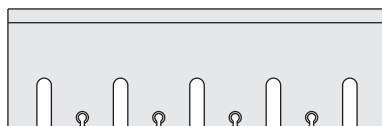

470x150x12

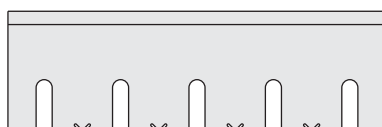

470x150x12

SEGEM



470x150x12



470x160x16



650x150x12



650x150x12



650x150x16



840x160x12



910x150x12

Daráló kések

SG STROJIRNA

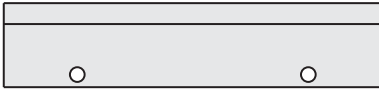

360x80x15

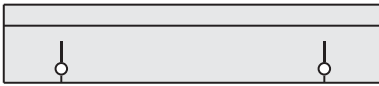

460x95x16

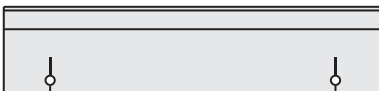

530x120x20

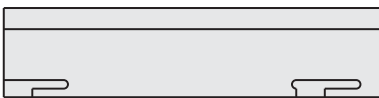

530x125x20

SIBA / ABC

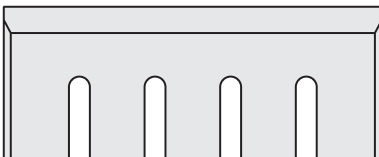

325x130x12

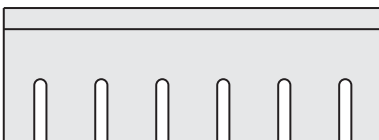

465x165x16



665x175x16

SIBA / ABC

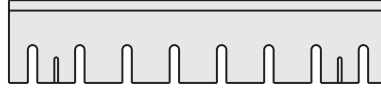

800x175x15/16

SJÖLINS

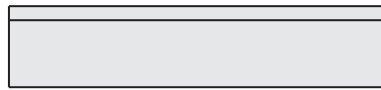

350x75x10



550x75x10

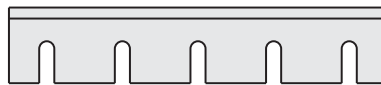

550x110x10
Model: 170M, 180M, 190M



700x110x10

SÖDERHAMN

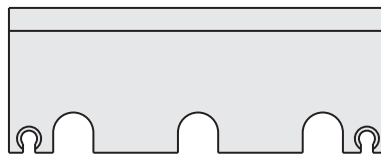

298,5x114,3x12, 7

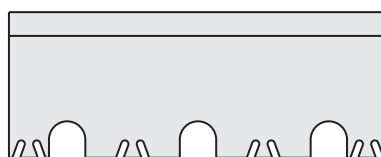

330x127x12, 7

SÖDERHAMN

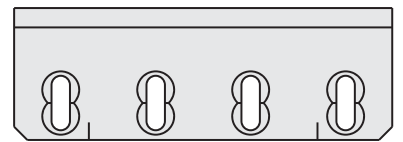

430x150x16
Model: 670-56A, 671-56A



711x127x12, 7

SPRINGER

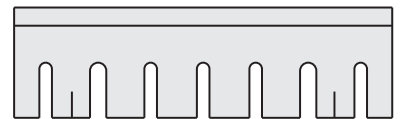

720x210x20

SUMNER

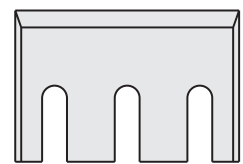

225x152x13

VECOPLAN

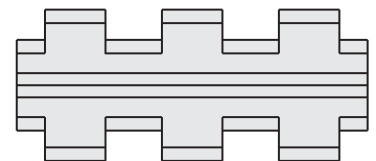

174x75x25
Model: 35NR

Daráló kések

VECOPLAN

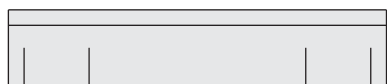

349x70x10

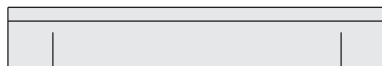

530x85x14
Model: HTH100(150,200)x500

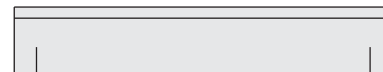

680x120x14

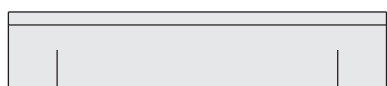

349x70x10



580x85x10

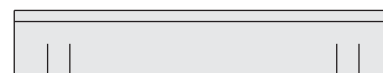

680x120x14

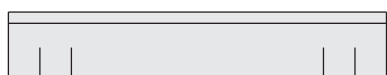

480x85x10
Model: 45/14,45/12



580x85x10

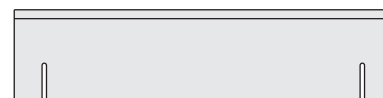

680x160x20

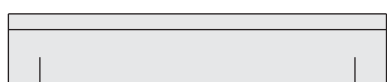

480x90x14
Model: 45/18/2

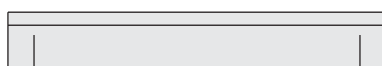

580x90x14
Model: 55/16/2



680x180x25

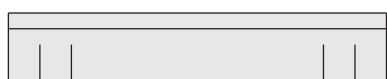

480x90x14
Model: 45/18/2

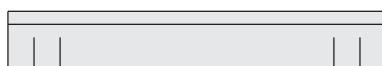

580x90x14
Model: 55/16/2

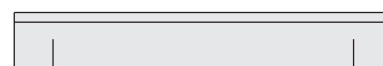

780x120x14

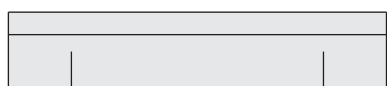

480x100x20

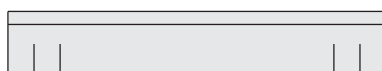

580x100x14
Model: 55/16/2



780x160x20

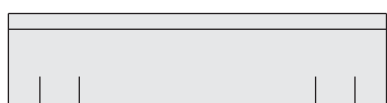

480x120x14
Model: 45/18/4



580x120x14

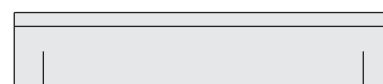

780x160x20

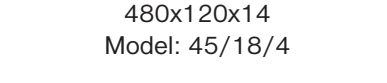

680x90x14
Model: 65/20HR

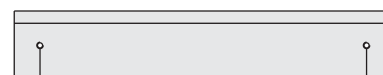

880x160x20



980x85x10

Daráló kések

VECOPLAN



980x120x20
Model: 95R/35R-HR

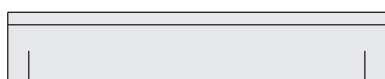

1080x200x25



1080x200x25

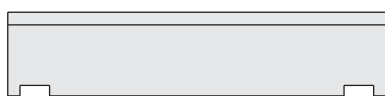

1085x240x25

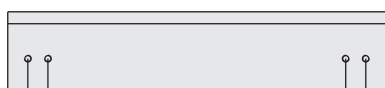

1130x240x25



1280x240x25

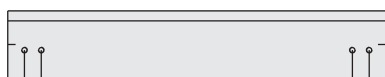

1350x240x25

VERMEER

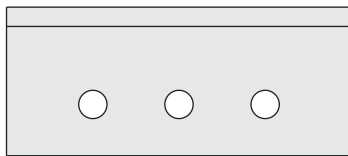

203x89x9,5
Model: 1220, 1230, 1250

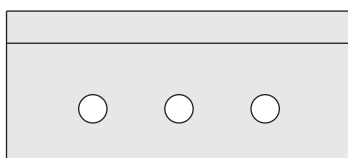

203x89x15,9
Model: 620, 625

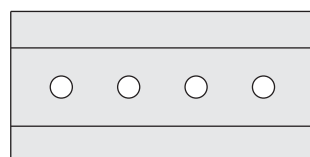

228x114x15,9
Model: BC 1000

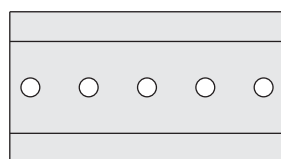

254x140x15,9

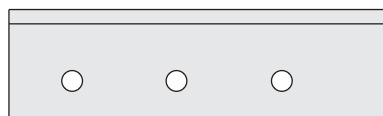

304x89x9,6
Model: 606, 906, 935

WAYNE

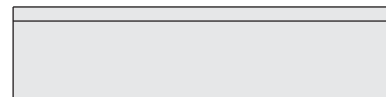

305x76,2x9,5

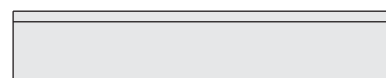

406x76x9,5

WIGGER

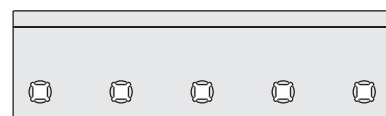

700x200x20

ZENO

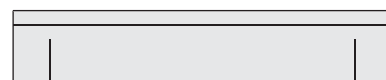

515x100x14

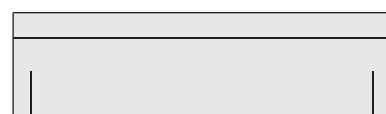

515x100x20



1595x200x25

Gerenda megmunkáló kések



Ipari kések

Gerenda megmunkáló kések

Alapanyag: speciális chipper acél, aprító és daráló késekre kifejlesztve

Felhasználás: a késeket elsősorban faaprító központokban használják, ahol a munkafolyamat része a gerenda megmunkálása.

Jellemzők:

- » a hőkezelés speciális, számítógéppel vezérelt kemencékben történik
- » a kések keménysége és élszöge a megrendelő kívánsága szerint készül
- » bármilyen kés gyártása adott dokumentáció vagy minta alapján
- » a kések mellett még szállítunk ellenkéseket, nyomólapokat és egyéb elemeket

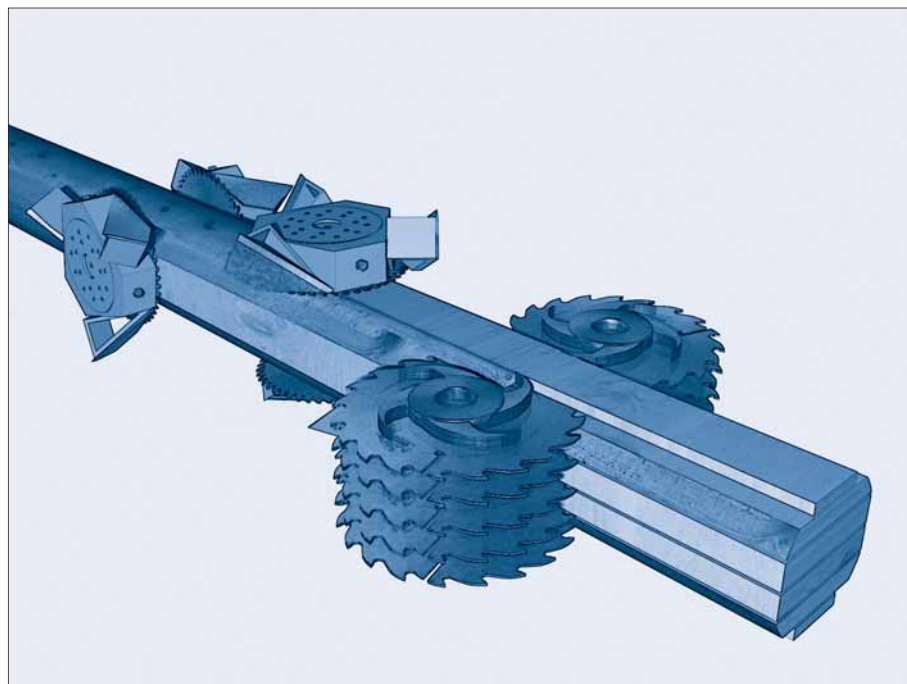

Az alábbi géptípusokhoz gyártunk késeket

Ahlström	EWD	Linck	Segem
Bongioanni	Forano	Linder	Söderhamn
CAE	Heinola	Mem	Wurster
Comact	Hew saw	Sawqiup	
Esterer	LBL	Schenck	

Gerenda megmunkáló kések

BONGIOANNI

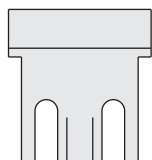

66x70x10

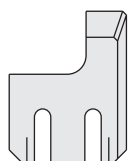

93x120x15 L

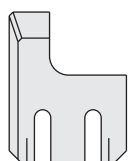

93x120x15 P

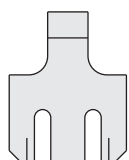

93x120x15 S

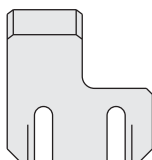

120x125x15 L

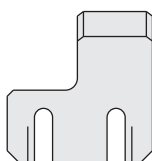

120x125x15 P

BONGIOANNI

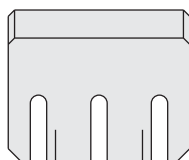

144x120x15

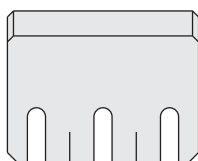

158x125x15

CAE

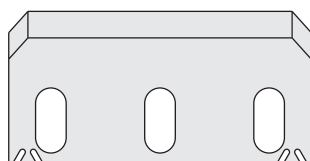

250,8x125,4x12,7

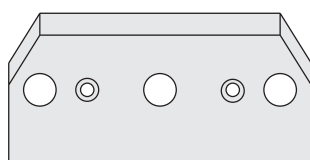

250,8x111x9,5

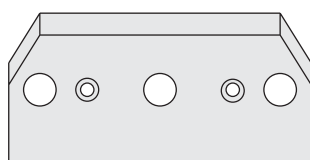

250x125,4x9,5

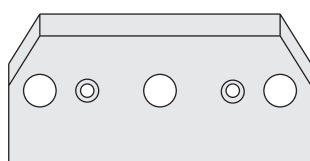

250,8x125,4x12,7

COMACT

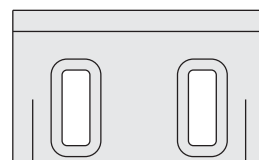

254x152x16
Model: 60"

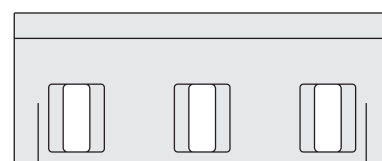

338x136x16

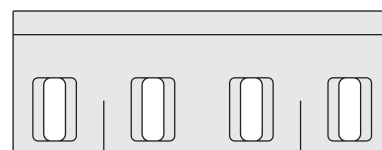

365x136,5x16
Model: 48"

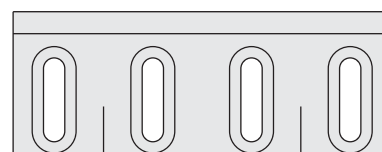

365x136,5x16
Model: 48"

ESTERER



200x110x12

Gerenda megmunkáló kések

ESTERER

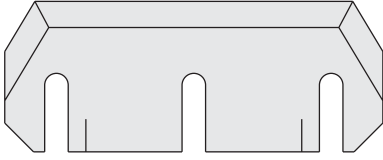

289x115x12

EWD

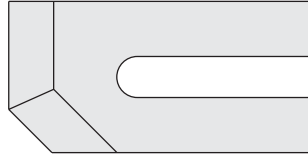

140x70x12 L

EWD

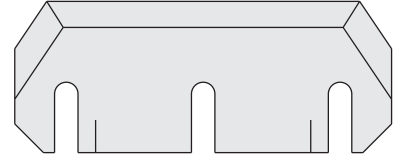

289x116x12

EWD

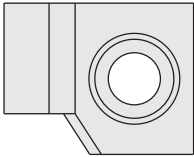

48x38,3x8,6

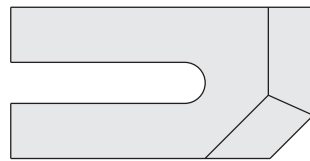

140x70x12 P

FERRARI

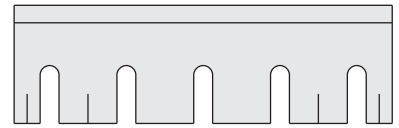

320x100x10

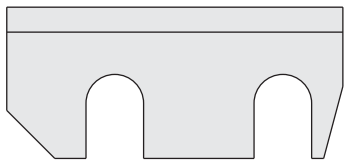

70x31,5x3

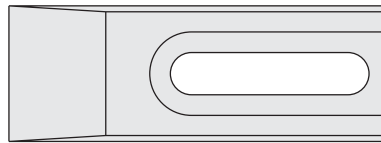

145x52x26

FORANO

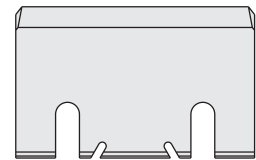

190,5x120,7x9,5

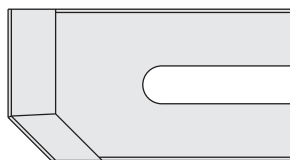

131x69,9x12

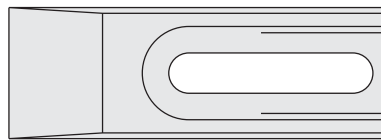

150x52x26

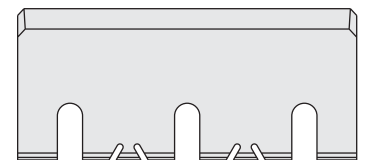

269x120x9,5

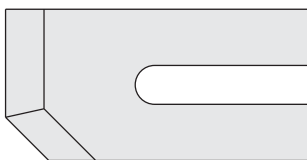

140x70x12

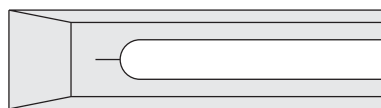

153x40x14,5

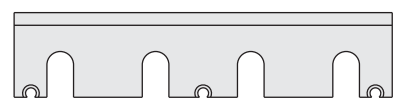

454x101,6x9,5
Model: 58"

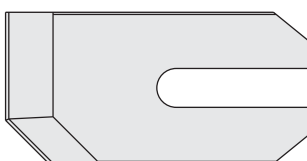

140x70x12

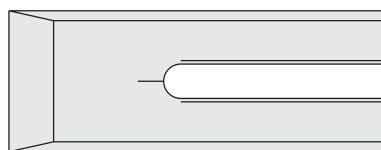

220x82x15

Gerenda megmunkáló kések

HEINOLA / AHLSTRÖM

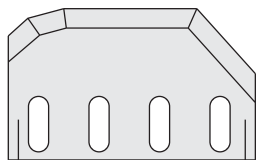

245x150x12 L
Model: Sk6

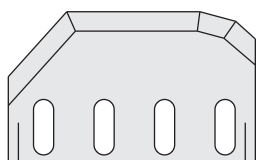

245x150x12 P
Model: Sk6

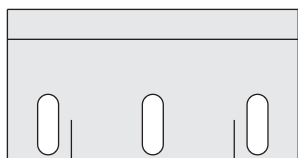

250x130x12

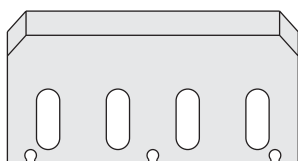

250x130x12

LBL

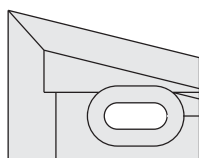

105x83x22

LBL



235x100x18

LINCK

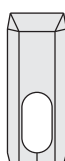

41x105x8

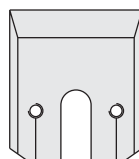

92x105x12

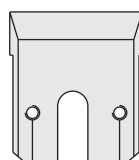

92x105x12



50x105,5x10

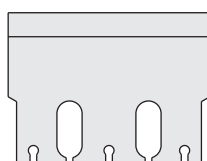

120x90x10

LINCK

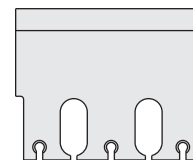

120x95x10

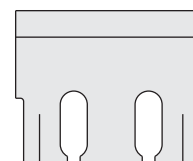

120x95x10

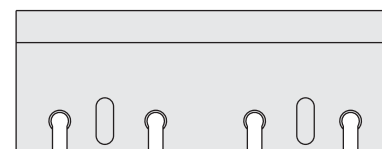

130x48x8

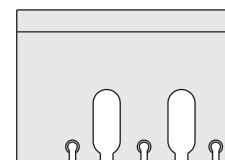

140x95x10

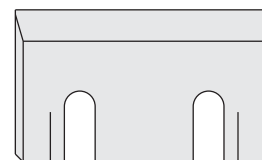

184x108x14

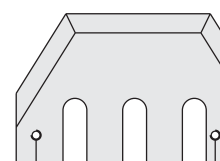

215x152x12

Gerenda megmunkáló kések

LINCK

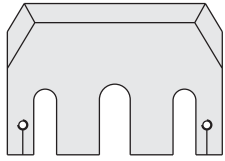

216x152x12

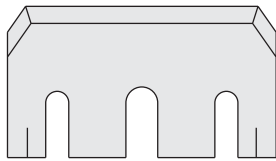

270x152x12

SCHENCK

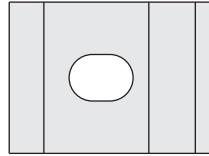

175x130x25

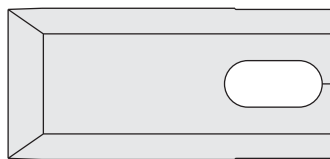

200x130x22

WURSTER

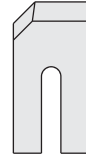

70x140x12 L



70x140x12 P

MEM

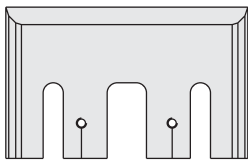

240x150x10

SÖDERHAMN



250x107x12

MORBARK

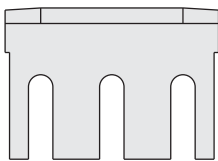

152,4x108x11,1
Model: PS 8



250x107x12

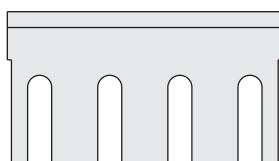

200x110x11,5

WURSTER

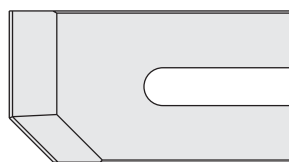

131x69,9x12

Funér hámozó – hántoló kések



Ipari kések

Funér hámozó – hántoló kések

Alapanyag:	speciális chipper acél, hántoló és aprító késekre kifejlesztve, CHIPPER 1.2362, 1.2631, A8 Solid kivitel
Felhasználás:	szeletelés, hántolás, vágás
Géptípus:	hántoló és funérhámozó gépek

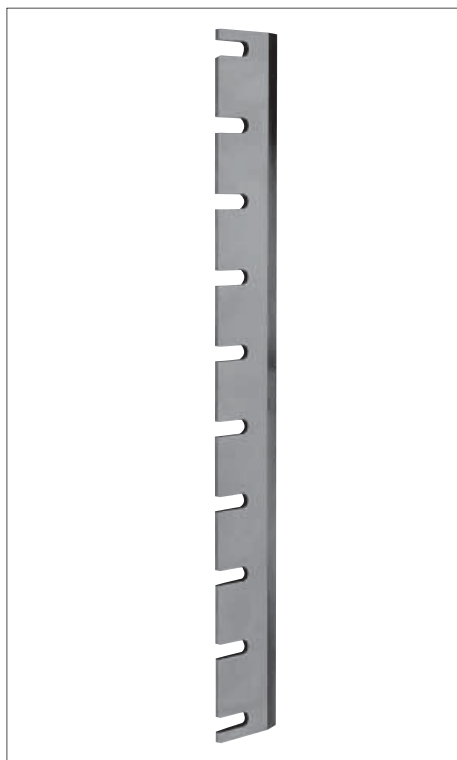

Jellemzők:

- » hántoló kések 57 és 60 HRC között
- » a hőkezelés speciális, számítógéppel vezérelt kemencékben történik
- » élszög: cca 20
- » a kések mellett még szállítunk ellenkéseket, nyomólapokat és egyéb elemeket

Az alábbi géptípusokhoz gyártunk késeket

AEW	Derouleuse	Chambon	Minami	Shonai	Uroko
Arizun	Derulor	John	Monguzi	Sodeme	Valette
Brugg	Fezer	Josting	Muller	Tai-Hei	Victor
Capital	Fisher	Jusan	Nishigami	Tai-Yuan	Watarai
COE	FRF	Kaiser	Peller	Takekana	Weitina
Colombo	Fudder	Kelner	PM I	Tanouchi	Zuen Kwan
Coral	Fukushima	KPS	Rapidex	Temil	
Cremona	Hasimoto	Marunaka	Raute	Thoms/ Benato	
Dahol	Hattori	Meinan Aristo	RFR	Tromag	

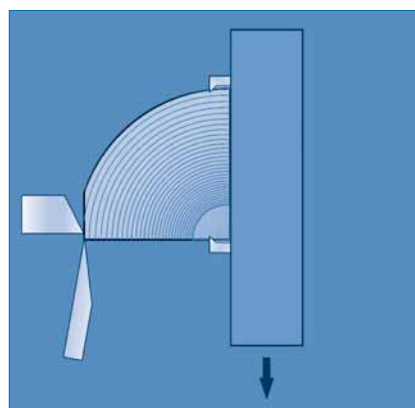
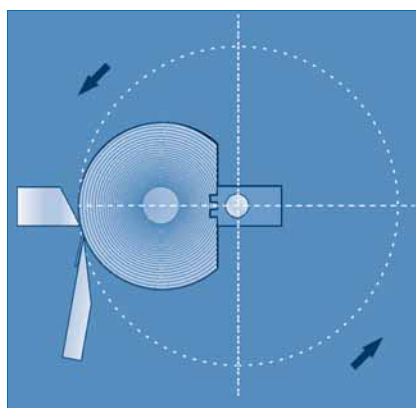
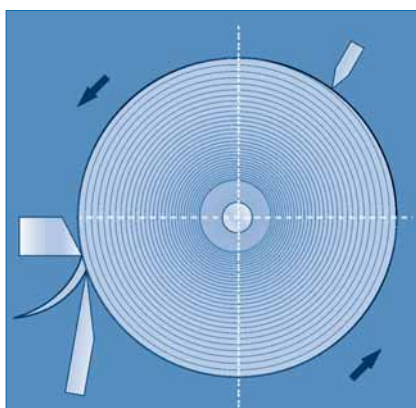

Funér hámozó – hántoló kések

CORALI



900x140x12



950x140x12

JUSAN

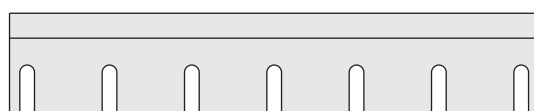

1220x140x16



1320x140x16

CREMONA

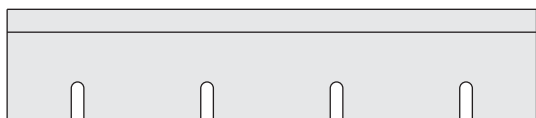

838x180x15



1200x180x15



1500x180x15



1690x190x16



1700x190x16



1778x180x15



1900x180x16

KELLER

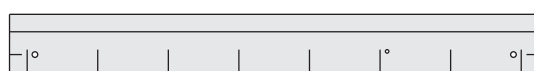

1500x180x18



1700x180x18



1900x180x18

KPS



1500x180x15



1848x180x15

MINAMI



1350x100x10

Funér hámozó – hántoló kések

RAPIDEX

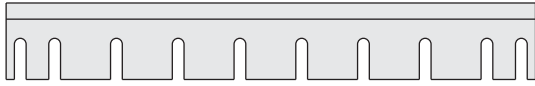

900x130x10

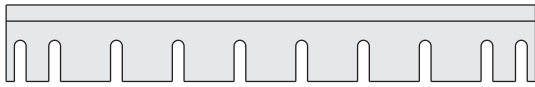

900x130x12

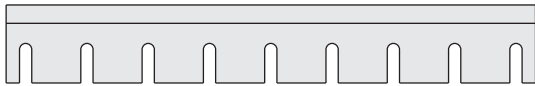

900x167x10

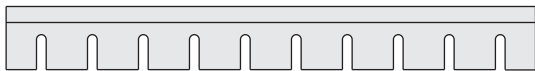

950x120x10

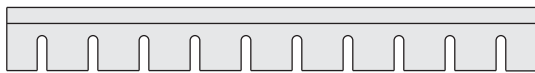

1090x130x10



1090x130x12



1400x140x12

RAUTE



1350x197x16



1400x180x16

RAUTE



1650x197x16

SODEME

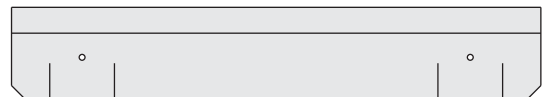

900x155x16

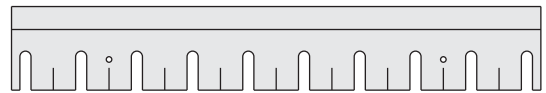

950x150x15

TAKEKAWA



1180x135x14

TEMIL



1800x220x16

VALETTE

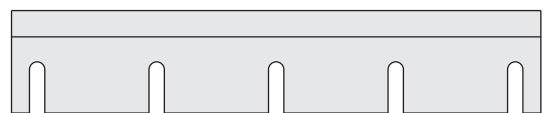

620x120x10



1470x150x16

Funér hámozó – hántoló kések

CAPITAL



2800x190x18

CREMONA



2160x180x15



2365x160x15



2800x180x15



2800x190x16



4110x200x15

DEROULEUSE



2666x170x15



3700x170x15

Funér hámozó – hántoló kések

DERULOR

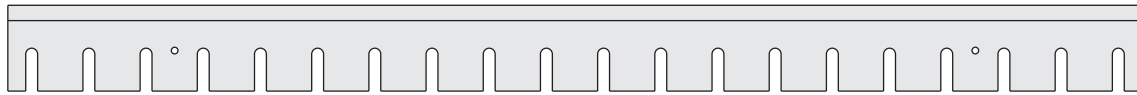

2380x180x15

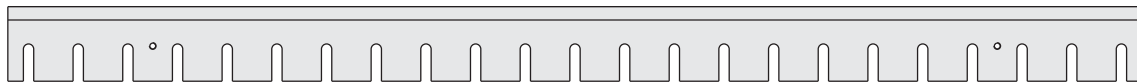

2740x180x15

J + Y

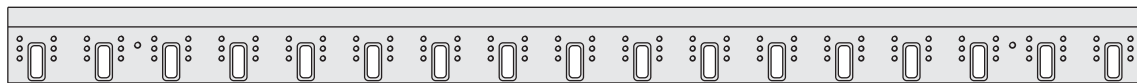

3000x200x22

JOSTING

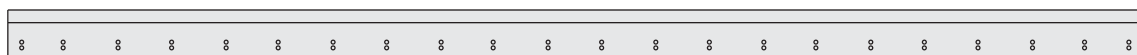

2950x120x12

KELLER



2400x180x18

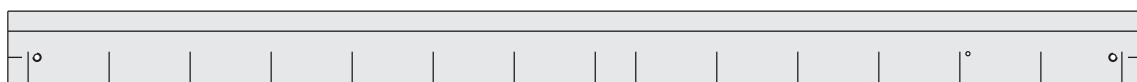

2800x180x18



3400x180x18

KPS

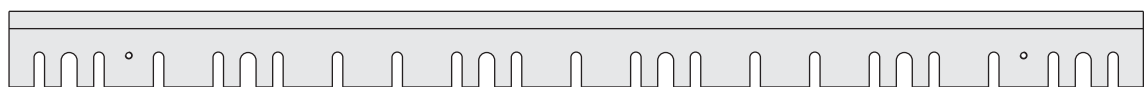

2700x180x15



4170x190x15

Funér hámozó – hántoló kések

NORMACA



2720x100x10

PELLER



2892x170x15,5

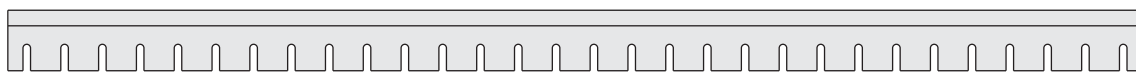

3000x160x15

RAUTE

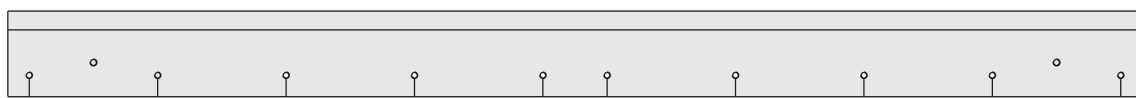

2650x197x16



2800x190x18

RFR



2769x190,5x16



3146x235x15



4050x170x18

Funér hámozó – hántoló kések

RFR



4060x235x15

TAKEKAWA



2010x140x13

TEMIL



2700x220x16

UROKO



2760x200x16

Korona kések



Ipari kések

Korona kések

Alapanyag: speciális acél ipari kések gyártására kifejlesztve, szerszámacél, 19573, cementált acél, DS

Felhasználás: fa és műanyag hulladékanyag feldolgozása

Géptípus: örlőgépek

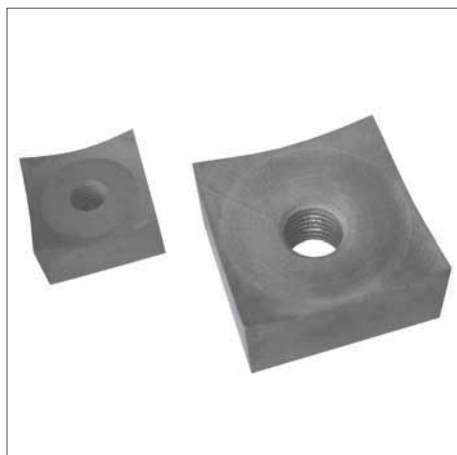

Jellemzők:

- » leggyakrabban négyzet vagy körforma
- » a koronakések 52 és 59 HRC között készülnek, fémszennyezett hulladék feldolgozásához alacsonyabb keménységet javasolunk.
- » a hőkezelés speciális, számítógéppel vezérelt kemencékben történik
- » egyéb elemek: rögzítők és egyéb kések

Az alábbi géptípusokhoz gyártunk késeket

Bano	Haas	Reinbold	Untha	Weima	Zeno
BMH	Miller	TPA	Vecoplan	Weis	

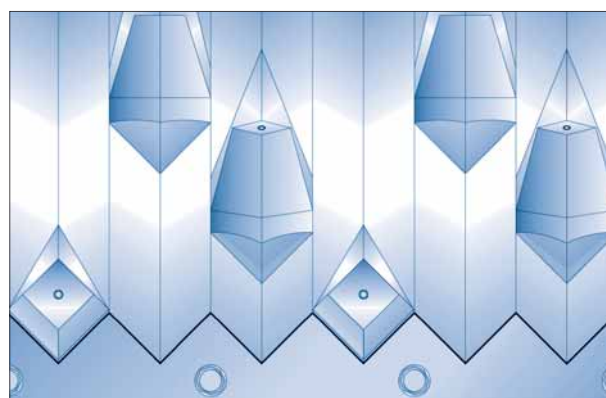
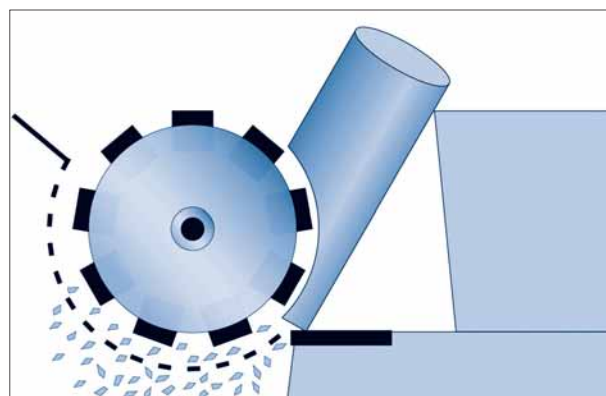

Korona kések

BANO

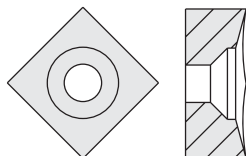

30x30x17

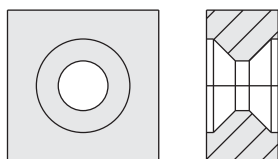

38x38x18

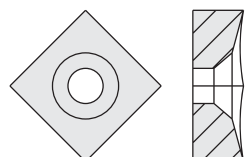

38x38x18

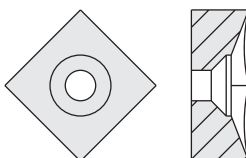

43x43x23

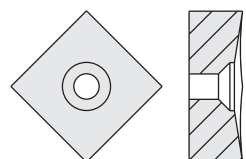

60x60x30

BMH

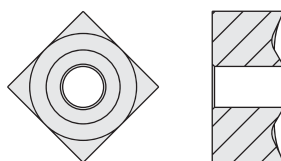

47x47x31,5

BMH

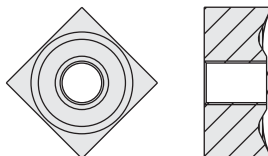

54x54x34

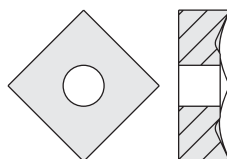

94x94x45

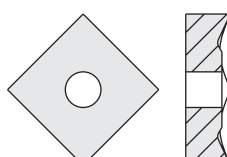

108x108x45

GROSS

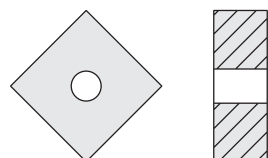

30x30x15

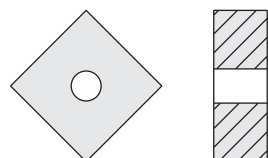

30x30x20

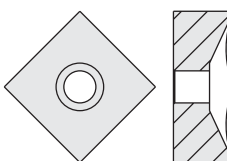

35x35x20

GROSS

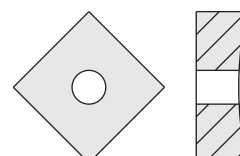

35x35x20

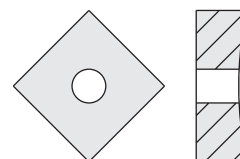

36x36x20

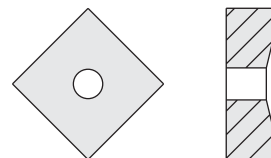

40x40x20

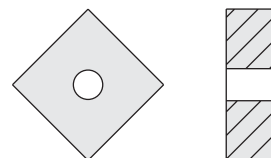

40x40x20

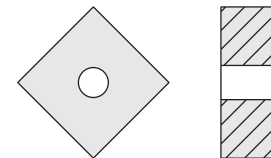

50x50x20

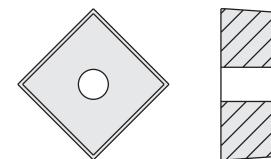

50x50x25

Korona kések

GROSS

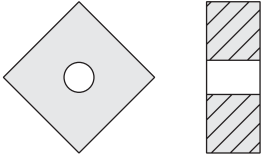

50x50x25

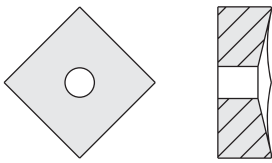

50x50x25

REINBOLD

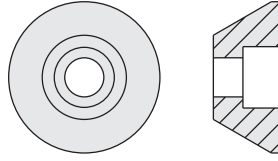

rad 66,5x29

RUDNICK

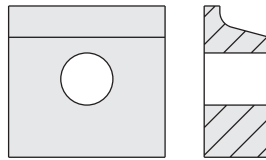

60x58x25

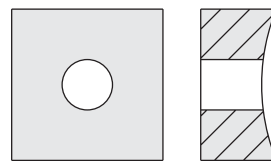

60x60x30

SG

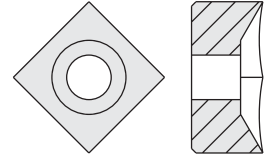

24x24x16

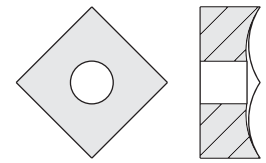

30x30x18

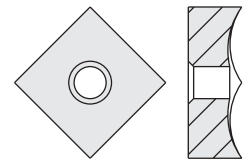

39x39x22

HERBOLD

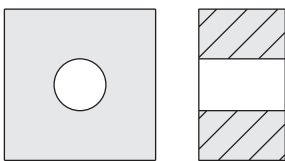

35x35x20

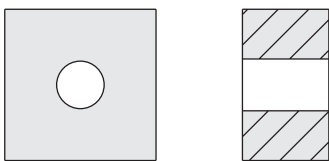

35x35x25

SCOINER

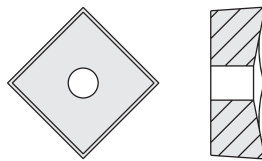

30x30x20

TPA

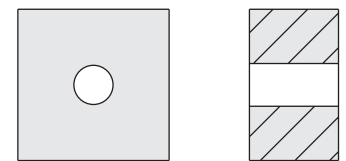

42,45x42,45x25

REINBOLD

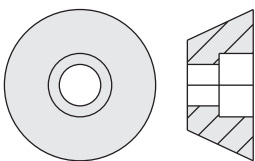

rad 62x27

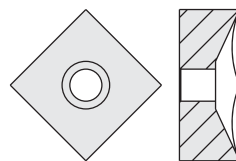

40x40x20

UNTHA

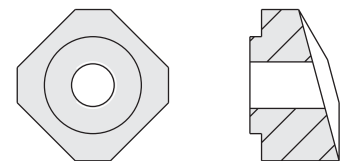

34x34x23

Korona kések

VECOPLAN

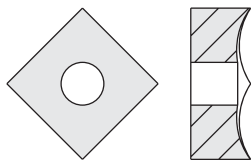

30x30x20

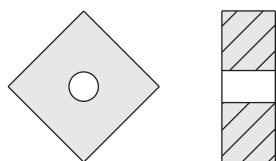

30x30x20

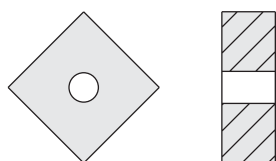

40x40x20

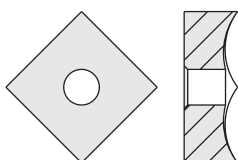

60x60x30

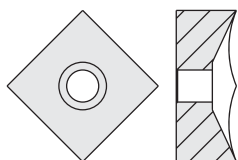

80x80x45

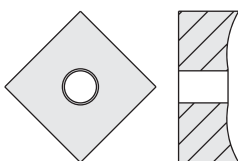

80x80x45

VMC

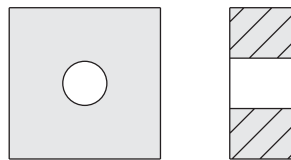

48x48x20

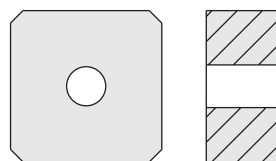

85x85x40

WEIMA

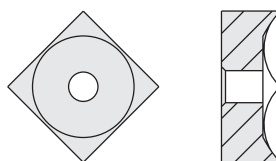

40x40x22

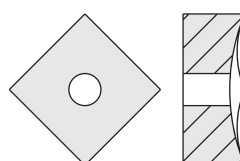

40x40x23

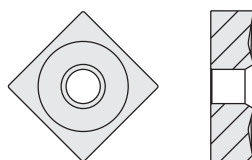

50x50x20

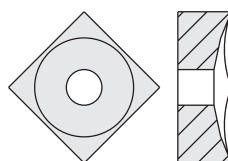

60x60x30

WEIMA

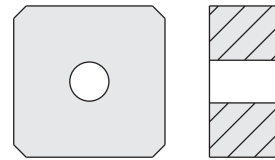

80x80x35

WEISS

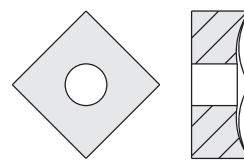

30x30x19

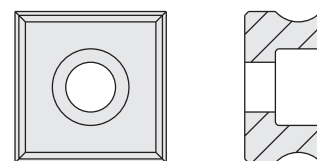

39,5x39,5x20

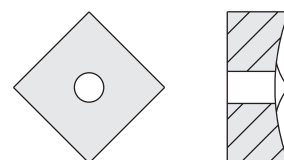

40x40x23

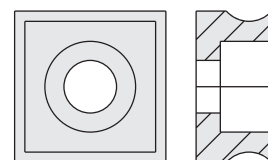

49,5x49,5x25

Aprítógépkések műanyagra



Ipari kések

Aprítógépkések műanyagra

Alapanyag: HLS - 1.2379 - D2, CHIPPER - 1.2362 - A8
Felhasználás: műanyag hulladék feldolgozása
Géptípus: daráló gépek

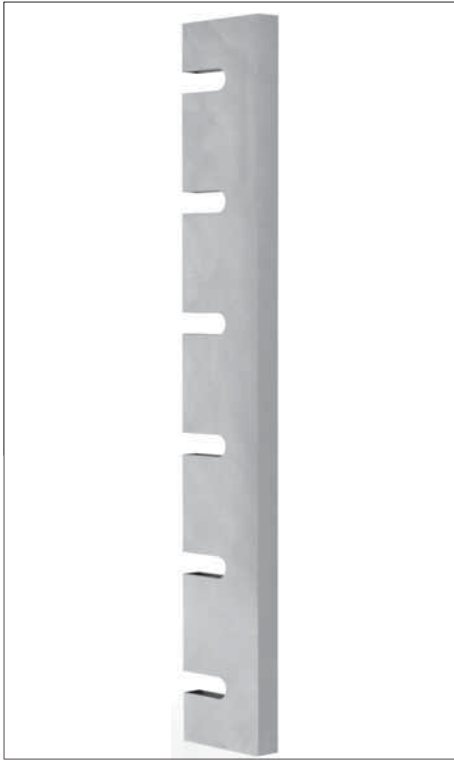

Jellemzők:

- » a kések 56 és 59 HRC keménységgel készülnek
- » a hőkezelés speciális, számítógéppel vezérelt kemencékben történik
- » élszög: cca 50 géptípustól és a felhasznált alapanyagtól függően
- » egyéb elemek: rotorkések és egyéb kések
- » bármilyen aprítógépkés készítése adott dokumentáció vagy minta alapján

Az alábbi géptípusokhoz gyártunk késeket

Alpine	Corcoran	Gloucester	Lodi	Rainville	Tria
Alsteele/Entoleter	Cumberland	Granotec	Mitts/Merrill	Ramco R&S	Triple S
Berlyn	Dreher	Gruendler	Nelmor	Rapid	Wortex
Black Friar	Dryflo	Herbold	Pallmann	Rotogran	
CMB	Falzoni	Hydraclaim	Polymer	Sorema	
Conair	Flinchbaugh (FPI)	IMS	Previero	Sprout Waldren	
Condux	Foremost	Intrapala	Process Control	Taylor Styles	

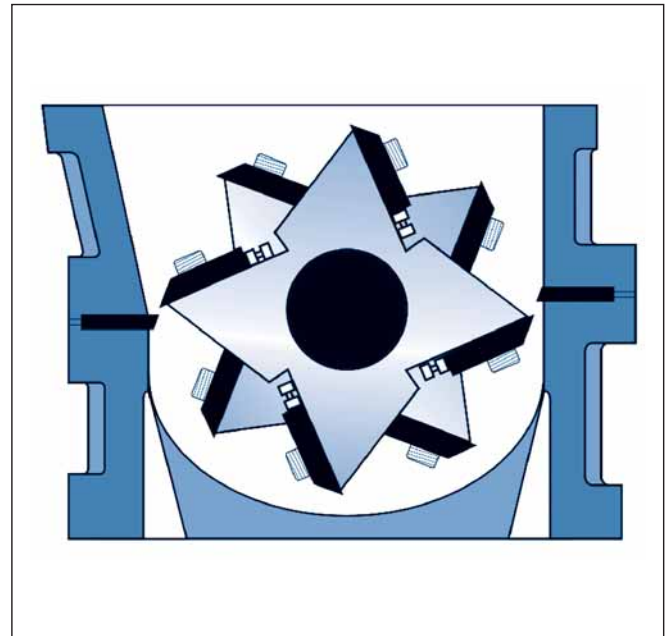
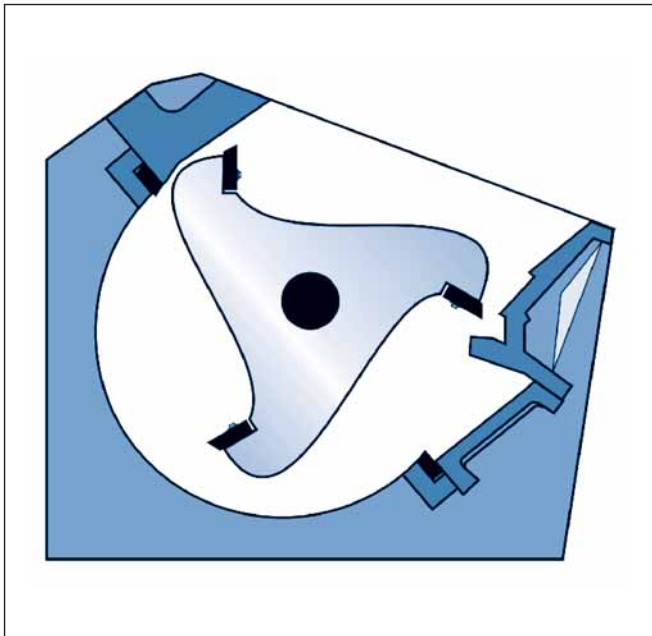

Aprítógépek műanyagra

ALPINE

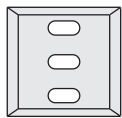

104 x 100 x 12 rotor
Model: 20/18



125 x 83 x 16 rotor
Model: A 20112



125,4 x 20 x 20 rotor
Model: A 20112

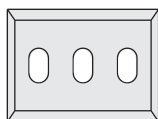

140 x 104 x 12 rotor
Model: B 25/14



155 x 20 x 20 rotor
Model: B 25/14

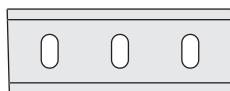

161,7 x 60 x 9 rotor
Model: B 63/12

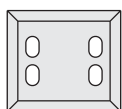

180 x 160 x 20 rotor
Model: Rotoplex 63/18



190 x 32 x 20 rotor
Model: Rotoplex 63/18

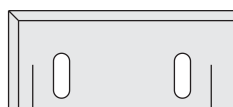

197 x 85 x 15 rotor
Model: 28/40



200 x 85 x 15 L rotor
Model: 28/60



200 x 85 x 15 P rotor
Model: 28/60



200 x 85 x 15 rotor
Model: 28/60



210 x 30 x 28 rotor
Model: 40/63

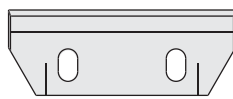

210 x 79 x 20



210 x 90 x 16 rotor
Model: 40/63



210 x 90 x 20 L rotor
Model: 50/80

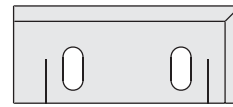

210 x 90 x 20 P rotor
Model: 50/80



210 x 90 x 20 rotor
Model: 50/80

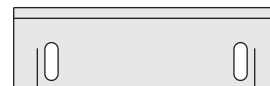

280 x 85 x 15 rotor
Model: 28/28



302 x 75 x 15 rotor
Model: 28/28



329 x 55 x 10 rotor
Model: 16/32



340 x 90 x 25 rotor
Model: 45/100



398 x 87 x 16 rotor
Model: 32/40



399,6 x 30 x 28 rotor
Model: 32/40



620 x 87,25 x 16 rotor
Model: 28/60

Aprítógépkések műanyagra

ALPINE



633 x 65 x 8 rotor
Model: 36/60



708 x 100 x 20 rotor
Model: 45/71

BARCLAY

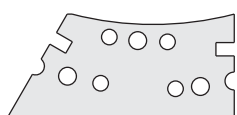

161,93 x 73,91 x 25,4

CMB



150 x 22 x 4,05 rotor
Model: QTE 3



150 x 53 x 14 rotor
Model: B 1.5 VIS



153 x 22 x 4,05 rotor
Model: QTE 2

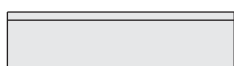

153 x 38 x 9,5 rotor
Model: B 1.5 VIS



159 x 38 x 16

CMB

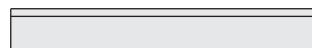

160 x 22 x 4,05 rotor
Model: QTE 2



179,5 x 50 x 12 rotor
Model: MB 1818

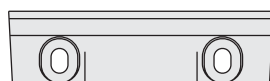

203 x 56 x 14 rotor
Model: MS 22

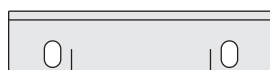

209,5 x 50 x 12 rotor
Model: MS 22



215 x 76 x 18 rotor
Model: MS 44



217,5 x 76 x 22



249 x 118 x 25 rotor
Model: MS 600

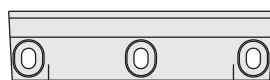

292 x 76 x 22 rotor
Model: MS 33

CMB



296 x 76 x 18 rotor
Model: MS 33



299,5 x 76 x 18 rotor
Model: MS 33



395 x 118 x 25 rotor
Model: MS 68



399 x 118 x 25 rotor
Model: MS 68



436 x 76 x 22 rotor
Model: MS 49

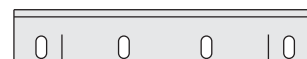

439,5 x 76 x 18 rotor
Model: MS 44



495 x 118 x 25 rotor
Model: MS 610

CONAIR



292,1 x 50,8 x 12,7 rotor
Model: 10 x 12

Aprítógépkések műanyagra

CONAIR



445,2 x 97 x 18 rotor
Model: 14x18



469,9 x 83 x 18,08 rotor
Model: Gk 1418, Gk 4535



508 x 73 x 25,4 rotor
Model: 12x20, 14x20

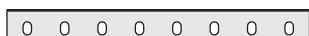

513,5 x 49,2 x 12,7 rotor
Model: 14x20



609,6 x 87,5 x 28



711,2 x 111,1 x 22,22 rotor
Model: 20x28

CUMBERLAND



168 x 42,8 x 6,9 rotor
Model: 6" pell



206,4 x 97,6 x 30,2 rotor
Model: 50 18



256,9 x 84,1 x 12,7 rotor
Model: 30803

CUMBERLAND



260,3 x 52,4 x 12,7
Model: 8x100, 1/84



295,3 x 34,9 x 6,4 rotor
Model: 11"



301,6 x 73 x 12,7



204,8 x 96,3 x 12,7 rotor
Model: 18x36



305,5 x 54 x 12,7 rotor
Model: 18x36, 18x24



308 x 98 x 12,7 rotor
Model: 18x36



334,5 x 82,5 x 12,7 rotor
Model: 30834



334,5 x 87 x 15,8 rotor
Model: 14x26



335 x 69,85 x 12,7 stator
Model: 6-84 14x64

CUMBERLAND



355,6 x 35 x 6,35 rotor
Model: 14" PELL 24K



355,6 x 58,72 x 9,52 rotor
Model: 14" paletizer



357,2 x 111,1 x 19,05 rotor
Model: X 700



358,8 x 98 x 22,22 stator
Model: X 700



360,3 x 111,1 x 19,05 rotor
Model: 24x28



382,5 x 73 x 15,87 rotor
Model: 30"



387,3 x 96,8 x 22,22 stator
Model: 20"



405,6 x 84,1 x 12,7 rotor
Model: 14x16



411,15 x 69,85 x 12,7 stator
Model: 30773

Aprítógépkések műanyagra

CUMBERLAND



412,7 x 71,4 x 12,7 stator
Model: 12x16, 16x16

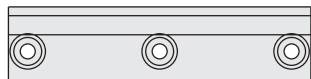

447,7 x 111,1 x 28,6 rotor
Model: 32x50



471,5 x 108 x 19,05 rotor
Model: 18x37



471,5 x 109,7 x 28,6 rotor
Model: 37B



471,5 x 110,5 x 19,05 rotor
Model: 18x37



474,6 x 96,8 x 22,22 stator
Model: 37,37 B, 18x37



474,6 x 108,2 x 22,22 stator
Model: 37"



506,4 x 57,2 x 15,9 rotor
Model: 20 granulator



506,4 x 57,2 x 15,9 rotor
Model: 20 granulator



507,2 x 82,5 x 9,5 rotor
Model: 14x20, 12x20, 16x20



507,2 x 84,1 x 12,7 rotor
Model: 14x20



507,2 x 85,7 x 22,22 rotor
Model: 20 granulator



508,7 x 109,5 x 28,58 rotor
Model: 20x40, C 1000



508,8 x 111,1 x 19,05 rotor
Model: 20x40, X 1000



512,3 x 66,4 x 12,7 stator
Model: 20x40, C 1000



512,7 x 71,4 x 12,7 stator
Model: 16x20



512,7 x 98,4 x 22,22 stator
Model: X1000, C1000



514,3 x 71,4 x 12,7 stator
Model: 14x20



528 x 109 x 28,5 rotor
Model: 18x42



533,8 x 98,4 x 15 stator
Model: 18x42

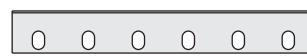

547,7 x 76,2 x 19,05 rotor
Model: 43



551,9 x 95,8 x 22,22 stator
Model: 43



609,6 x 92,1 x 22,22 stator
Model: 24 B



617,5 x 84,1 x 15,8 stator
Model: 15x24



625,5 x 108 x 19,05 stator
Model: 50, 20x50



635 x 109,5 x 19,05 rotor
Model: 50



635 x 109,7 x 28,6 rotor
Model: 50B



638,2 x 97,5 x 22,22 stator
Model: 50, 20x50

Aprítógépek műanyagra

CUMBERLAND



711,2 x 96,82 x 22,22 stator
Model: X 1400



711,2 x 107,67 x 19,05 rotor
Model: 28,18x28



711,2 x 110,2 x 19,05 rotor
Model: 28,18x28



712 x 111,1 x 19,05 rotor
Model: X 1400



714,3 x 98,4 x 22,22 stator
Model: X 1400

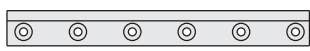

723,9 x 84,1 x 17 rotor
Model: 56 1



777,8 x 109,7 x 27,76 rotor
Model: 14x62,62 B



914,4 x 109,7 x 28,57 rotor
Model: 72B,20x72



917,6 x 96,8 x 22,22 stator
Model: 72B,18x72

DIPRE



75 x 58 x 8 rotor

DIPRE

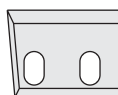

101,5 x 78 x 10 rotor



395,5 x 70 x 10 rotor



402 x 69,5 x 13 stator
Model: Granulator



502,5 x 70 x 10
Model: GRM 30050



508 x 82 x 13 rotor
Model: GRM 400 50



509 x 69,5 x 13 stator
Model: GRM 300 50



515 x 68 x 13 stator
Model: GRM 400 50

ENGIN PLAST



245 x 66,5 x 12

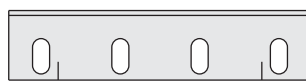

248 x 57 x 11

ENGIN PLAST



299 x 83 x 20



338 x 48 x 11



338 x 58 x 11



379 x 93 x 25



393,5 x 92 x 19



398 x 78 x 20

EREMA



40 x 58 x 4



130 x 35 x 3

FOREMOST

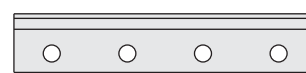

330,2 x 98,4 x 22,22 rotor
Model: HD 1, HD 5

Aprítógépkések műanyagra

FOREMOST

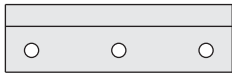

330,2 x 98,4 x 22,22 rotor
Model:SHD 8



355,6 x 49 x 15,8 stator
Model:HD 2



444,5 x 66,67 x 12,7 rotor
Model:SMS 18



457,2 x 49,2 x 30,1



457,2 x 57,15 x 15,87 stator
Model: HD 6



609,6 x 76,2 x 25,4



711,2 x 57,15 x 15,88 stator
Model: HO 4,SG 50



914,4 x 73 x 25,4 stator

GRANUTEC



403,2 x 60,3 x 12,7 stator
Model:16x39



403,2 x 92 x 15,87 rotor
Model:14x16,16x16

GRANUTEC



606,4 x 60,3 x 12,7 stator
Model:12x24,14x24,16x24

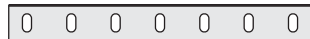

606,4 x 73 x 15,87 stator
Model:14x24



606,4 x 92,1 x 15,9



806,4 x 92 x 15,88 rotor
Model: 16x32

HERBOLD



195 x 85 x 16 stator
Model:SML 20/20



200 x 70 x 12 rotor
Model:SML 20/20

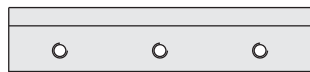

204 x 46 x 8 stator
Model:5189



210 x 79 x 20 rotor
Model:SML 35/42

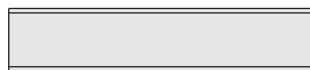

217 x 45 x 18 stator
Model:GS 300/200

HERBOLD



246 x 55 x 10 rotor
Model:Kg 16/15,Tg 16/15



250 x 43 x 6 rotor
Model:PS 5/10



250 x 45 x 6 rotor
Model:PS 5/10



250 x 80 x 10 rotor
Model:PS 3



250 x 80 x 15 stator
Model:PS 4-2



250 x 80 x 15 stator
Model:PS 4-2



270 x 100 x 22 rotor
Model:SML 30/30

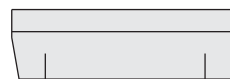

284 x 90 x 33 rotor
Model:SMS 45/60



290 x 85 x 16 stator
Model:SML 30/30

Aprítógépek műanyagra

HERBOLD



296 x 100 x 22 stator
Model:SMS 45/30



300 x 56 x 14 rotor
Model:SML 22/30



300 x 67 x 14 stator
Model:SML 22/30

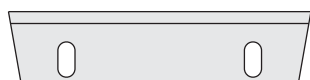

300 x 70 x 14 stator
Model:SML 22/30



320 x 100 x 22 rotor
Model:SMP 40/70

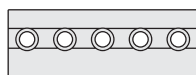

320 x 115 x 35 rotor
Model:CS 800/1600



320 x 120 x 62 rotor
Model:dreher 60



326 x 100 x 22 stator
Model:SMP 40/70



385 x 100 x 22 rotor
Model:SMS 45/80



423 x 67 x 20 stator
Model:SML 35/72



447 x 160 x 22 rotor
Model:SMS 60/100



450 x 95 x 20 rotor
Model:PS 8 9



460 x 90 x 16 stator
Model:SMS 30/50



470 x 70 x 16 rotor
Model:SMS 30/50



470 x 100 x 22 rotor
Model:SM 56/100



485 x 100 x 22 rotor
Model:SMS 45/100



488 x 100 x 22

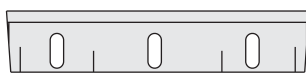

495 x 100 x 22 rotor
Model:SAS 45/100

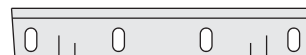

568 x 100 x 22 rotor
Model:SMS 45/60



590 x 100 x 22 stator
Model:SMS 45/60



595 x 100 x 22 stator
Model:SMS 45/60



600 x 90 x 18 rotor
Model:CS 300/600,CS 450/600



600 x 90 x 20 rotor
Model:CS 400/600



645 x 80 x 20 rotor
Model:CML 45/70

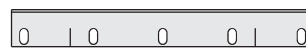

654 x 80 x 20 stator
Model:SML 45/70



700 x 100 x 28 rotor
Model:SM 80/70,80/40,120/70



705 x 100 x 17,5 rotor
Model:14/56



740 x 100 x 22 stator
Model:KG 80/45

Aprítógépkések műanyagra

HERBOLD



750 x 100 x 22 stator
Model:SML 60/145



770 x 100 x 22 rotor
Model:SML 30/80



790 x 85 x 16 stator
Model:SMS 30/80



795 x 100 x 22 rotor
Model:SM 450/800

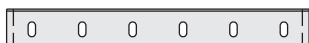

897 x 120 x 22 stator
Model:SMR 60/80



970 x 100 x 22 rotor
Model:SMS 45 100,60 100,80 100



978 x 105 x 24 stator
Model:S 60/100



995 x 100 x 22 stator
Model:SMS 45 100



1000 x 90 x 20 rotor
Model:CS 300/1000



1020 x 70 x 15 stator
Model:CS 500/1000



1178 x 100 x 22 stator
Model:SMS 80 120

NELMOR



241,3 x 60,3 x 11,1 rotor
Model:G 810M-1,AN 1010m-1



253,2 x 47,6 x 9,5



292,1 x 69,8 x 12,7 rotor
Model:10x12



368,3 x 92,1 x 15,9 rotor
Model:12x15



371,5 x 31,75 x 9,52 rotor
Model:14" paletizer



373,8 x 69,9 x 15,9 stator
Model:G 12299N-1



373,8 x 81,1 x 15,9 stator
Model:G 1830m-1



380,2 x 69,9 x 16 stator
Model:G 1215M-1



454 x 95,3 x 19,1 rotor
Model:G1436MB,G2036MB

NELMOR

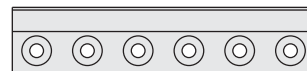

454 x 100 x 25,4 rotor
Model:G1426,g2436



455,6 x 88,9 x 19,05 stator
Model:14x36,24x3



471,5 x 100 x 25,4 rotor
Model:G2056M B



471,5 x 108 x 19,05 stator
Model:G2056M B



473,1 x 88,9 x 19,05 rotor
Model:G2056



507,2 x 81,1 x 15,87 stator
Model:G 27 16



557,2 x 101,6 x 25,4 rotor
Model:22 44,22 66



558,8 x 93,8 x 19



597 x 95,2 x 19 rotor
Model:G 14 24,G 12 24,G 14 48



608 x 88,9 x 19,1 stator
Model:G1425M

Aprítógépek műanyagra

PIERRET



640 x 120 x 11,1 rotor

POLYMER

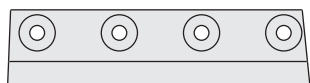

292,1 x 74,6 x 14,3



604,8 x 64,4 x 14,3

PREVIERO



514 x 88 x 24



600 x 78 x 19 rotor
Model: MU 412



600 x 98 x 24 rotor
Model: MU 39 11



609 x 68 x 19 stator
Model: Mu412



614 x 98 x 24 stator
Model: MU 39010



667 x 98 x 24 rotor
Model: MU 820

PREVIERO



675 x 98 x 24 stator
Model: MU 820



800 x 98 x 24 rotor
Model: MU 916



812,8 x 98 x 24 rotor
Model: MU 916

RAMCO



456,9 x 69,9 x 15,9



458,3 x 22,2 x 58,4

RAPID

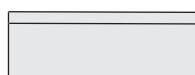

68,5 x 24 x 5 rotor
Model: GK 1415

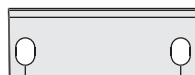

180 x 64 x 12 rotor
Model: GK 2036



262 x 95 x 24 rotor
Model: GM100RS,2442RS

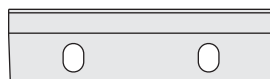

295,2 x 82,5 x 18,08
rotor Model: 28x24

RAPID

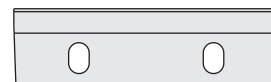

296,5 x 83,3 x 18,03 rotor
Model: 18x24



300,48 x 73 x 14 rotor
Model: FK 3026,10X12



304 x 74 x 14 rotor
Model: GK600,GK650



308,4 x 98,4 x 12,7 stator
Model: 10x12

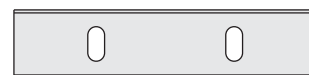

324,5 x 73 x 14 stator
Model: 10x12



390 x 80 x 20 stator
Model: Gk8045



390 x 95 x 20 rotor
Model: 18x31



450 x 81 x 18 rotor
Model: Gk3545



451 x 73 x 14 rotor
Model: Gk2635

Aprítógépkések műanyagra

RAPID



468 x 73 x 14 stator
Model: Gk2645

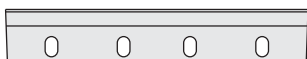

524 x 95 x 24 rotor
Model: Gm1000



600 x 100 x 18 rotor
Model: Gk3560



618 x 73 x 14 stator
Model: Gk3560



630 x 47 x 14 stator
Model: Gk40



795,3 x 70 x 20 stator
Model: Gk8045



918 x 74,5 x 14 stator
Model: Gk2690

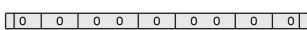

1060 x 54 x 34 stator
Model: GK 100



1119,3 x 46 x 30 stator
Model: Gk1000

TAYLOR



584 x 108,2 x 19 stator

TAYLOR



984,3 x 108,2 x 19,05 rotor
Model: 536



984,3 x 120,6 x 19,05 stator
Model: 536



984,3 x 129,4 x 31 stator

TRIA



619 x 125 x 28 stator



638,2 x 100 x 22

TRIPLE



609,6 x 76,2 x 19,1 rotor
Model: 48"



609,6 x 76,2 x 19,1 rotor
Model: 48"



615,95 x 101,6 x 22,23 stator
Model: S 48,24 D

TRIA



414 x 90 x 22 rotor



510 x 120 x 28 rotor
Model: 150/90



512 x 129 x 28 stator
Model: 150/90



615 x 120 x 25



615 x 120 x 28 rotor



619 x 125 x 28 stator

Ipari kések egyéb felhasználásra



Ipari kések

Ipari kések egyéb felhasználásra

Alapanyag: speciális acél, ipari késekre kifejlesztve
Géptípus: különféle gépek

Az alábbi felhasználásra gyártunk ipari késeket:

- » gumiabroncs újrahasonosítás
- » hulladék feldolgozás
- » bőr feldolgozás
- » fém feldolgozás
- » cellulóz és papírgyártás
- » dohány feldolgozás
- » cigaretta gyártás
- » textil feldolgozás
- » csomagolóanyag gyártás
- » húsfeldolgozás
- » gumi feldolgozás

Jellemzők:

- » a hőkezelés speciális, számítógéppel vezérelt kemencékben történik
- » a késeket a megrendelő kívánsága szerinti élszöggel és keménységben gyártjuk
- » bármilyen aprítógépkés készítése adott dokumentáció vagy minta alapján
- » egyéb elemek: ellenkések, nyomólapok, és egyéb kiegészítők géptípustól függően

újrafeldolgozás ábrája

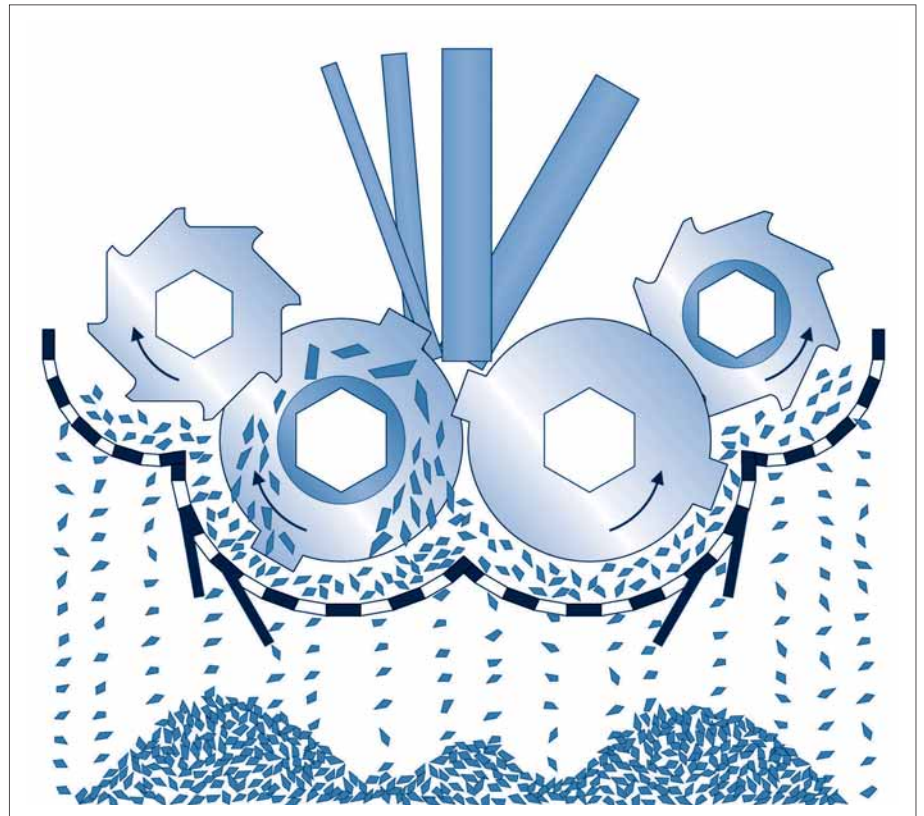



A katalógus csak angol nyelven készült

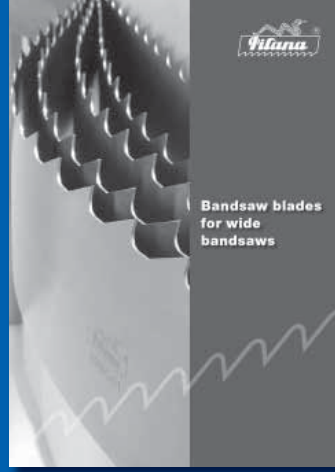

A Marófejek, gyalugépkések, profilkések katalógus csak angol-német-cseh verzióban készült



A Fémipari fűrészek katalógus csak cseh-angol-orsz verzióban készült



A STEEL CENTRES katalógus csak angol nyelven készült



PILANA TOOLS Knives
Nádražní 804, 768 24 Hulín
Phone: +420 573 328 465, Fax: +420 573 328 580
E-mail: knives@pilana.cz, www.pilana.cz